

---

# **FleetPC-5**

**In-Vehicle Computing**

## **User's Manual**

**Version 1.0**

---

---

**CarTFT.com**

**User Manual**

## **Copyright**

©2009 by CarTFT.com All Rights Reserved.

No part of this publication may be reproduced, transcribed, stored in a retrieval system, translated into any language, or transmitted in any form or by any means such as electronic, mechanical, magnetic, optical, chemical, photocopy, manual, or otherwise, without prior written permission from CarTFT.com

Other brands and product names used herein are for identification purposes only and may be trademarks of their respective owners.

## **Disclaimer**

CarTFT.com shall not be liable for any incidental or consequential damages resulting from the performance or use of this product.

CarTFT.com makes no representation or warranty regarding the content of this manual. Information in this manual had been carefully checked for accuracy; however, no guarantee is given as to the correctness of the contents. For continuing product improvement, CarTFT.com reserves the right to revise the manual or make changes to the specifications of this product at any time without notice and obligation to any person or entity regarding such change. The information contained in this manual is provided for general use by customers.

This device complies to Part 15 of the FCC Rules. Operation is subject to the following two conditions:

1. This device may not cause harmful interference.
2. This device must withstand any background interference including those that may cause undesired operation.

---

---

## Safety Information

Read the following precautions before setting up a CarTFT.com Product.

### Electrical safety

- To prevent electrical shock hazard, disconnect the power cable from the electrical outlet before relocating the system.
- When adding or removing devices to or from the system, ensure that the power cables for the devices are unplugged before the signal cables are connected. If possible, disconnect all power cables from the existing system before you add a device.
- Before connecting or removing signal cables from the motherboard, ensure that all power cables are unplugged.
- Seek professional assistance before using an adapter or extension cord. These devices could interrupt the grounding circuit.
- Make sure that your power supply is set to the correct voltage in your area. If you are not sure about the voltage of the electrical outlet you are using, contact your local power company.
- If the power supply is broken, do not try to fix it by yourself. Contact a qualified service technician or your retailer.

### Operation safety

- Before installing the motherboard and adding devices on it, carefully read all the manuals that came with the package.
- Before using the product, make sure all cables are correctly connected and the power cables are not damaged. If you detect any damage, contact your dealer immediately.
- To avoid short circuits, keep paper clips, screws, and staples away from connectors, slots, sockets and circuitry.
- Avoid dust, humidity, and temperature extremes. Do not place the product in any area where it may become wet.
- Place the product on a stable surface.
- If you encounter technical problems with the product, contact a qualified service technician or your retailer.

## CAUTION

Incorrectly replacing the battery may damage this computer. Replace only with the same or its equivalent as recommended by CarTFT.com. Dispose used battery according to the manufacturer's instructions.

---

---

## Table of contents

<b>(1) Introduction</b>	
1.1 Model Specifications	7
1.2 FleetPC-5 Illustration (Mainboard, System)	9
<b>(2) External connector specification</b>	
2.1 POWER IN connector	12
2.2 POWER BUTTON connector	12
2.3 DIO connector	13
2.4 RJ45 connector: (LAN0)	13
2.5 RJ45 connector: (LAN1)	14
2.6 COM Port connector: (COM1)	14
2.7 DVI-I connector: (DP1+VGA)	15
2.8 USB connector: (USB 0/1)	16
2.9 USB connector: (USB 2/3)	16
2.10 Audio connector	17
2.11 SIM CARD connector	17
2.12 UPS/3.5G LED	18
2.13 HDD/ACC LED	18
<b>(3) Internal connector /pin header specification</b>	
3.1 SATA power wafer connector	19
3.2 Reserved JST connector	19
3.3 COM port JST connector: (COM2)	20
3.4 COM port JST connector: (COM3)	20
3.5 COM port JST connector: (COM4)	21
3.6 DVI-D /LVDS connector: (DP0)	22
3.7 VGA JST connector	23
3.8 SATA 7PIN connector: (SATA1)	23
3.9 SATA 22PIN connector: (SATA0)	24
3.10 USB JST connector: (USB 4/5)	24
3.11 USB JST connector: (USB 6/7)	25
3.12 UPS JST connector	25
3.13 Download Port JST connector	26
3.14 BATTERY connector	26
3.15 RTC RESET connector	27

---

---

3.16 RS232 RI# Pin Power Select connector: (COM2)	27
3.17 RS232 RI# Pin Power Select connector: (COM1)	28
3.18 MINI CARD connector: (MINICARD0)	28
3.19 MINI CARD connector: (MINICARD1)	30
3.20 MINI CARD connector: (MINICARD2)	31
<b>(4) System Installation</b>	
4.1 System Introduction	33
4.2 Opening Chassis	34
4.3 Installing Memory	36
4.4 Installing MINI PCIe Expansion Card (PCIe 1)	38
4.5 Installing MINI PCIe Expansion Card (PCIe 2, Wifi Module)	39
4.6 Installing MINI PCIe Expansion Card (PCIe 3, 3G Module only)	40
4.7 Installing Internal Antenna Cable	41
4.8 Installing SIM Card	43
4.9 Installing HDD	44
<b>(5) System Resources</b>	
5.1 Ignition Power Management Quick Guide	45
5.2 GPIO & Delay Time Setting	47
5.3 Gobi2000 WWAN Module Applicatino Note	52
5.4 Gobi2000 GPS Module Application Note	56
<b>(6) BIOS</b>	
6.1 Super IO Configuration	61
<b>(7) Packing List</b>	
7.1 Packing List	63



## 1.1 Model Specification

System	
CPU	AMD G-T56N Dual Core 1.6GHz AMD G-T40N Dual Core 1.0GHz AMD G-T44R Single Core 1.2GHz (Optional)
Memory	2 x DDR3 1333MHz SO-DIMM up to 8GB
Chipset	AMD A55E Controller Hub
Graphics	AMD G-T56N Radeon HD 6310 / G-T44R Radeon HD 6250
LAN Chipset	2 x Realtek RTL8111E Gb/s Ethernet onboard Support PXE
Audio	Realtek ALC662 HD Codec onboard
Watchdog	1 ~ 255 Level Reset
Power Requirement	
Power Input	9V-32V DC Power input
Power Protection	Automatics Recovery Short Circuit Protection
Power Management	Vehicle Power Ignition for Variety Vehicle
Power Off Control	Power off Delay Time Setting by Software, Default is 5 Mins
Battery	Internal Battery Kit for 10 Mins Operating (Optional)

<b>Graphics</b>	
Graphics	AMD G-T56N Radeon HD 6310 / G-T44R Radeon HD 6250 1 X DVI-I connector and VGA on rear I/O
Resolution	Up to 2045 x 1560 @85H
<b>Storage</b>	
Type	2 x 2.5" drive bay for SATA Type Hard Disk Drive / SSD
<b>Qualification</b>	
Certifications	CE, FCC, Class A
<b>I/O</b>	
Serial Port	3 x RS-232 (COM1,2 with RS-422/485, RS-485 Support Auto Direction Control)
USB Port	4 x USB 2.0 Ports on Front I/O
LAN	2 x RJ45 Ports for GbE
Video Port	1 x DVI-I and 1 x VGA Output
DIO Port	4 in and 2 out with Relay 12V / 80mA
Audio	1 x Line-out (Default is 1 on Rear I/O)
SIM Card Socket	1 x SIM Card socket supported onboard with eject
<b>Environment</b>	
Operating Temp.	-30 ~ 60°C (SSD), ambient w/ air
Storage Temp.	-40 ~ 80°C
Relative Humidity	10 ~ 95% (non-condensing)
Vibration (random)	2.5g@5~500 Hz with SSD
Vibration Operating	MIL-STD-810F, Method 514.5, Category 20, Ground Vehicle-Highway
Truck Storage	MIL-STD-810F, Method 514.5, Category 24, Integrity Test
Shcok	Operating: MIL-STD-810F, Method 516.5, Procedure I, Trucks and semi-trailers=40G(11ms), Non-Operating 80G with SS
Crash Hazard	MIL-STD-810F, Method 516.5, Procedure V, Ground equipment=100
<b>Mechanical</b>	
Construction	Aluminum alloy
Mounting	Supports both of wall-mount/VESA-mount
Weight	1.5 kg (bard-bone)
Dimensions	250 x 150 x 55 mm

---

## 1.2 FleetPC-5 Illustration

### Mainboard

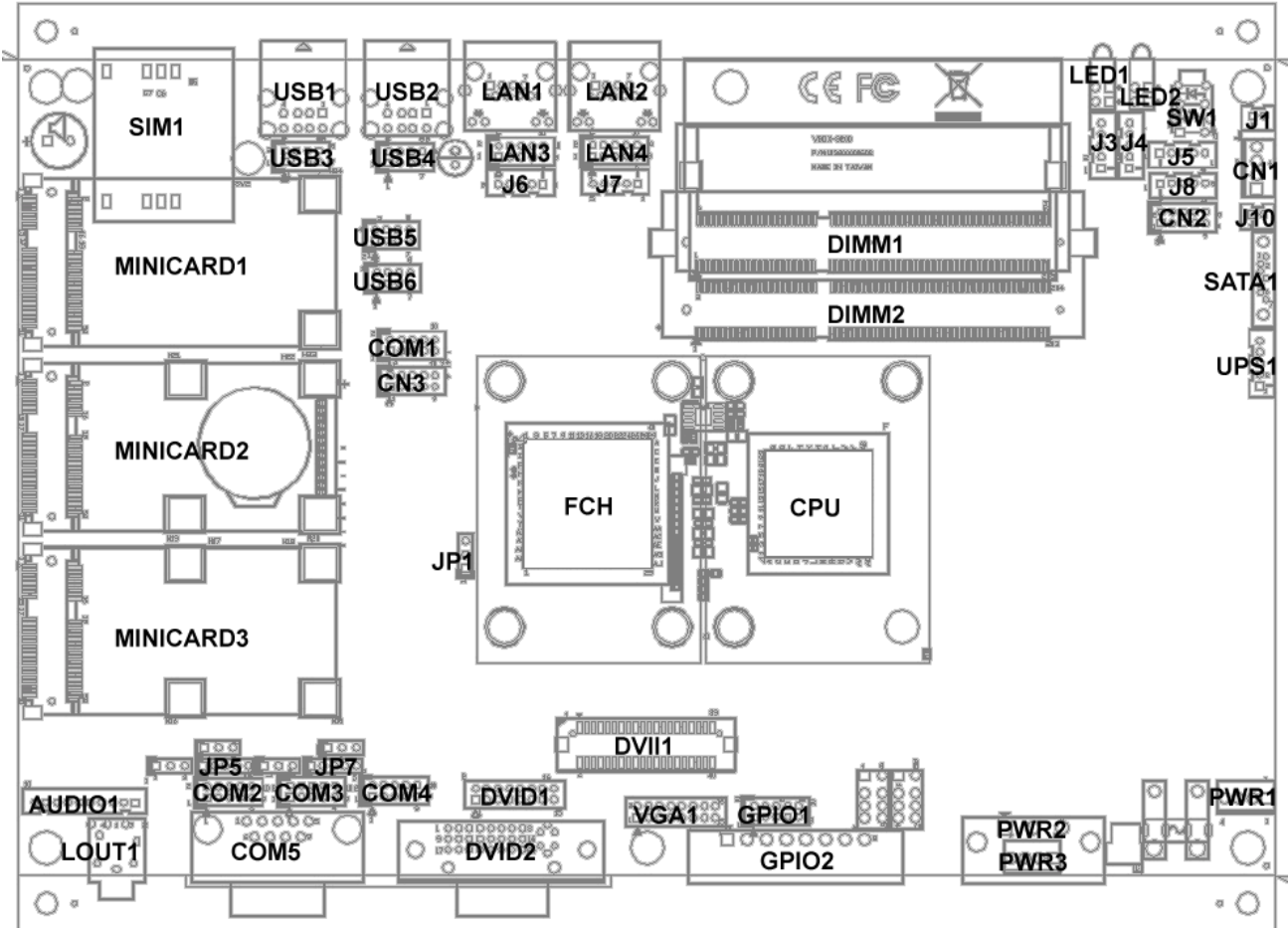



---

System

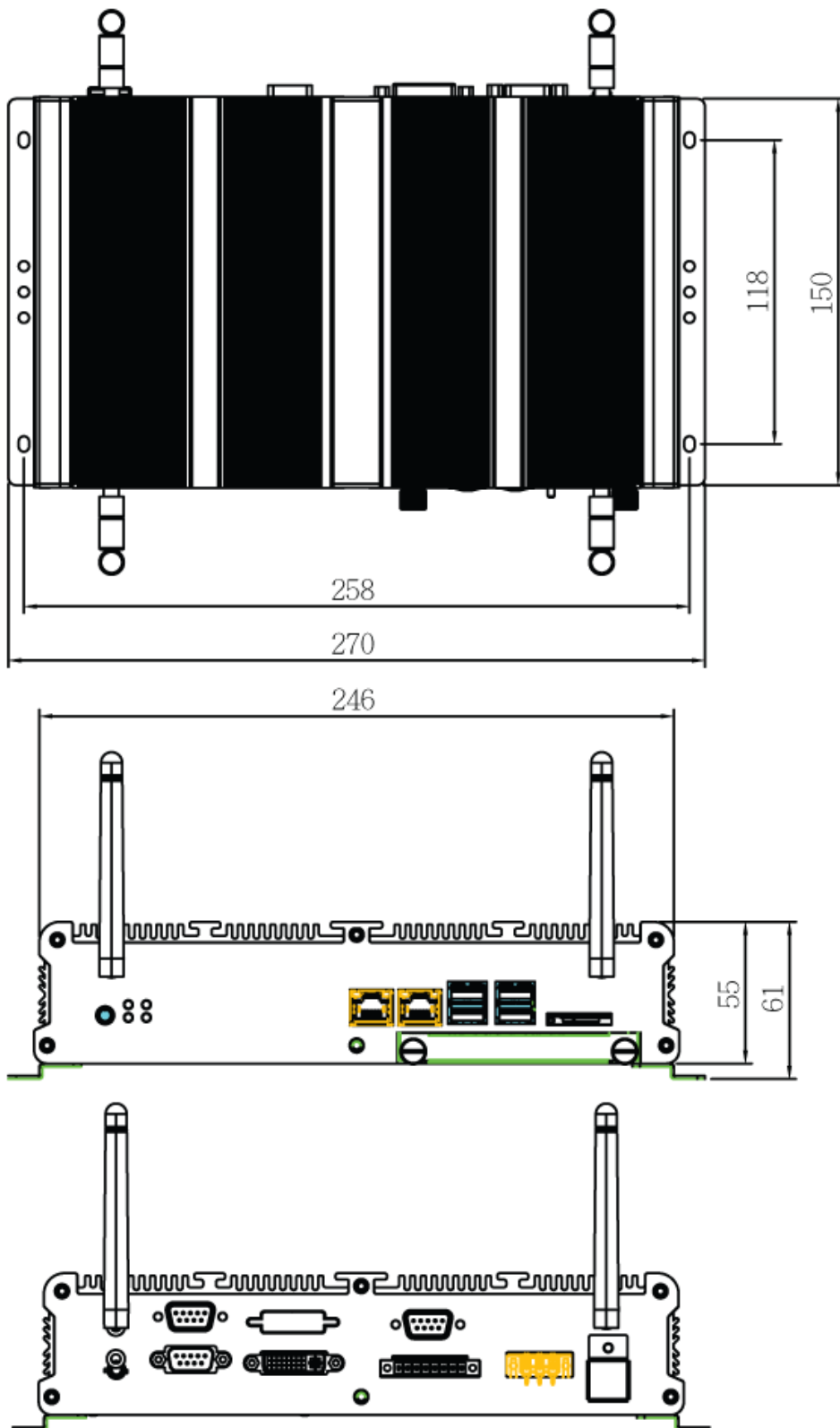

---

## (2) System Installation

### 2.1 System Introduction

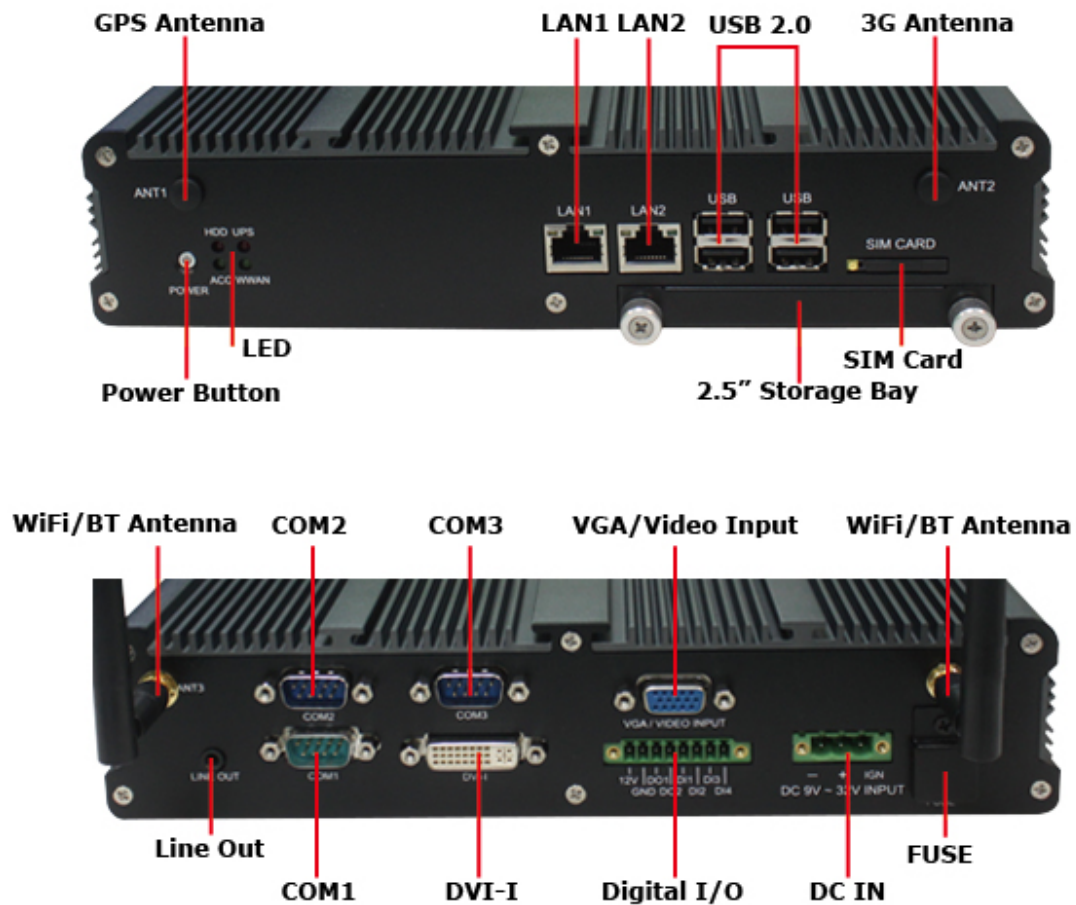

## (2) External connector specification

### 2.1 POWER IN connector:

- A. Connector size: 1 X 3 = 3 Pin
- B. Connector location: PWR2

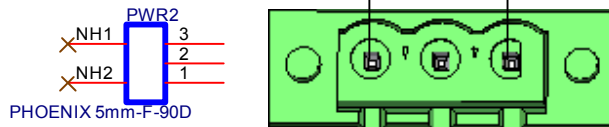

#### C. Connector pin definition

Pin	Signal
1	GND
2	DC_IN
3	IGNITION

### 2.2 POWER BUTTON connector:

- A. Connector size: 6 Pin
- B. Connector location: SW1

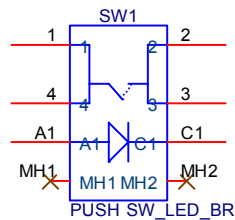

Pin	Definition
On	Blue light
Off	Red light

#### C. Connector pin definition

Pin	Signal	Pin	Signal
1	GND	2	PWRBT#
3	PWRBT#	4	GND
A1	LEN_N	C1	LED_P

### 2.3 DIO connector:

A. Connector size: 1 X 8 = 8 Pin

B. Connector location: GPIO2

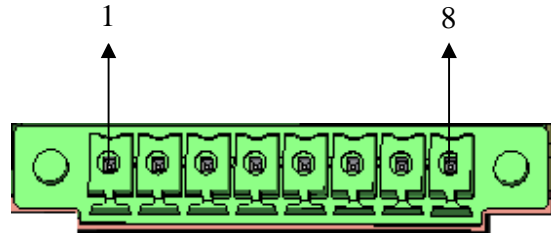
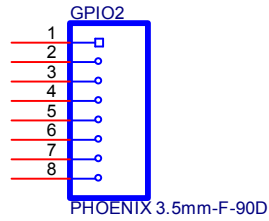

C. Connector pin definition

Pin	Signal
1	+12V
2	GND
3	GPO1
4	GPO2
5	GPI1
6	GPI2
7	GPI3
8	GPI4

### 2.4 RJ45 connector:

A. Connector size: RJ45+LED

B. Connector location: LAN2

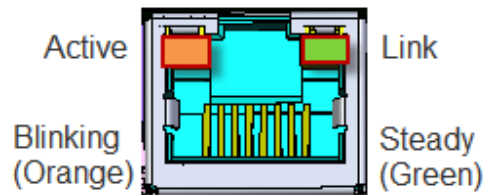
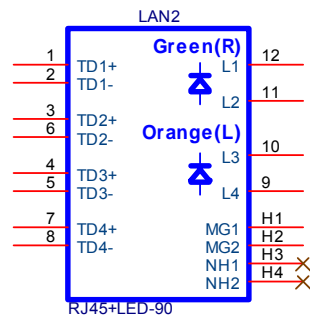

C. Connector pin definition

Pin	Signal	Pin	Signal
1	LAN0_MDI0P	2	LAN0_MDI0N
3	LAN0_MDI1P	4	LAN0_MDI2P
5	LAN0_MDI2N	6	LAN0_MDI1N
7	LAN0_MDI3P	8	LAN0_MDI3N
9	LAN0_ACT#	10	LAN0_ACTPW
11	LAN0_LINK#	12	LAN0_LINKPW

## 2.5 RJ45 connector:

A. Connector size: RJ45+LED

B. Connector location: LAN1

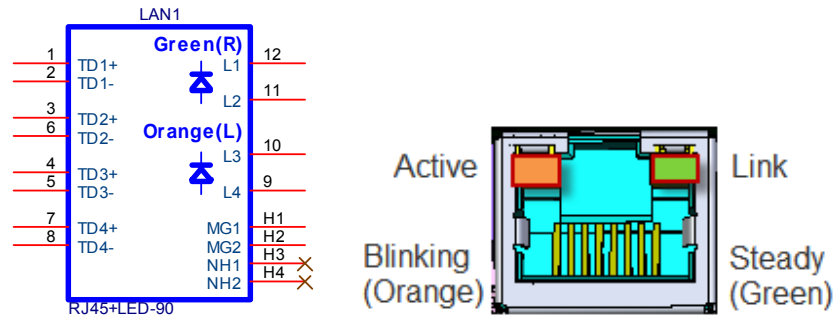

C. Connector pin definition

Pin	Signal	Pin	Signal
1	LAN1_MDI0P	2	LAN1_MDI0N
3	LAN1_MDI1P	4	LAN1_MDI2P
5	LAN1_MDI2N	6	LAN1_MDI1N
7	LAN1_MDI3P	8	LAN1_MDI3N
9	LAN1_ACT#	10	LAN1_ACTPW
11	LAN1_LINK#	12	LAN1_LINKPW

## 2.6 COM Port connector:

A. Connector size: DB9

B. Connector location: COM5

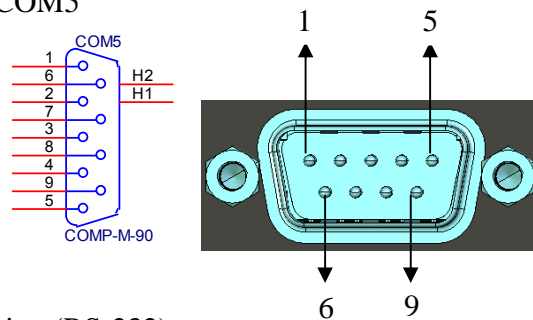

C. Connector pin definition (RS-232)

Pin	Signal	Pin	Signal
1	COM1_DCD	2	COM1_RXD
3	COM1_TXD	4	COM1_DTR
5	GND	6	COM1_DSR
7	COM1_RTS	8	COM1_CTS
9	COM1_RI /+5V /+12V		

D. Connector pin definition (RS-422)

Pin	Signal	Pin	Signal
1	COM1_TXD-	2	COM1_TXD+
3	COM1_TXD+	4	COM1_RXD-
5	NC	6	NC
7	NC	8	NC
9	NC		

E. Connector pin definition (RS-485)

Pin	Signal	Pin	Signal
1	COM1_TXD-/RXD-	2	COM1_TXD+/RXD+
3	NC	4	NC
5	NC	6	NC
7	NC	8	NC
9	NC		

2.7 DVI-I connector:

A. Connector size: DVI-I

B. Connector location: DVID2

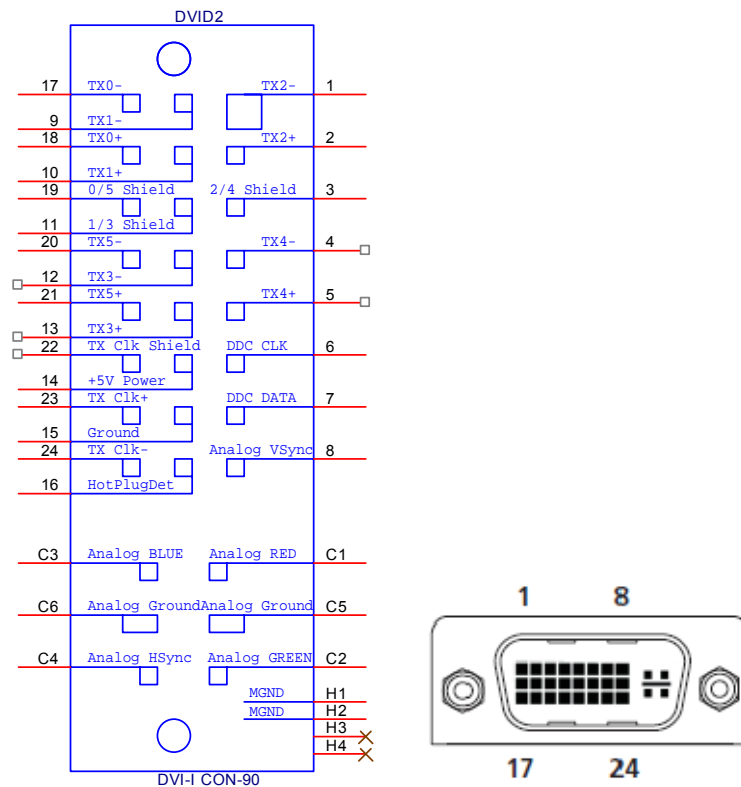

### C. Connector pin definition

Pin	Signal	Pin	Signal
1	DVI_TX2_N	2	DVI_TX2_P
3	GND	4	5VSB_USB
5	+12V_PWR	6	DVI_DDC_CLK
7	DVI_DDC_DATA	8	CRT_VSYNC
9	DVI_TX1_N	10	DVI_TX1_P
11	GND	12	USB_12N
13	USB_12P	14	+5V_DVI_PWR
15	GND	16	DVI_HPD
17	DVI_TX0_N	18	DVI_TX0_P
19	GND	20	CRT_DAC_SDA
21	CRT_DAC_SCL	22	NC
23	DVI_CLK_P	24	DVI_CLK_N
C1	CRT_RED	C2	CRT_GREEN
C3	CRT_BLUE	C4	CRT_HSYNC
C5	GND	C6	GND

## 2.8 USB connector:

A. Connector size: USB TYPEA

B. Connector location: USB2

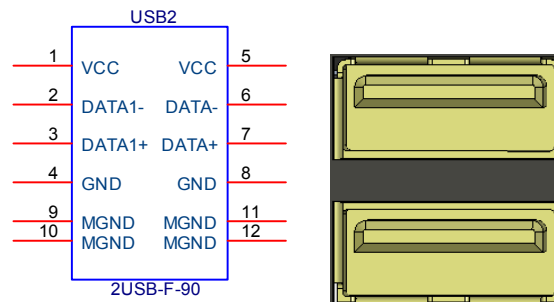

### C. Connector pin definition

Pin	Signal	Pin	Signal
1	5VSB_USB	2	USB0_N
3	USB0_P	4	GND
5	5VSB_USB	6	USB1_N
7	USB1_P	8	GND

## 2.9 USB connector:

A. Connector size: USB TYPEA

B. Connector location: USB1

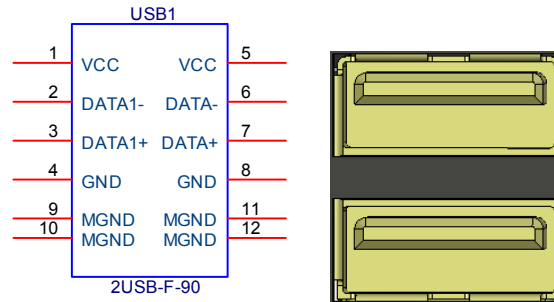

C. Connector pin definition

Pin	Signal	Pin	Signal
1	5VSB_USB	2	USB2_N
3	USB2_P	4	GND
5	5VSB_USB	6	USB3_N
7	USB3_P	8	GND

## 2.10 Audio connector:

A. Connector size: Phone Jack

B. Connector location: Audio2

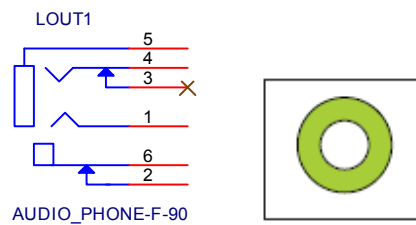

C. Connector pin definition

Pin	Signal	Pin	Signal
1	FRONT_OUT_L	2	FRONT-JD
3	NC	4	FRONT_OUT_R
5	GND	6	GND



## 2.11 SIM CARD connector:

- A. Connector size: 6 Pin
- B. Connector location: SIM1

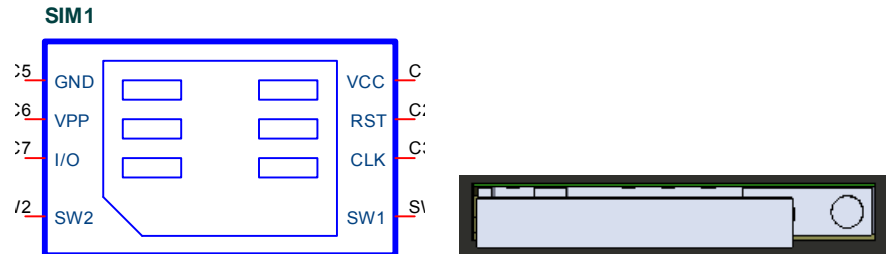

### C. Connector pin definition

Pin	Signal	Pin	Signal
C1	VCC	C5	GND
C2	RST	C6	VPP
C3	CLK	C7	DATA
SW1	GND	SW2	GND

## 2.12 UPS/3.5G LED:

- A. Connector size: 2 Layer LED with Housing
- B. Connector location: LED1

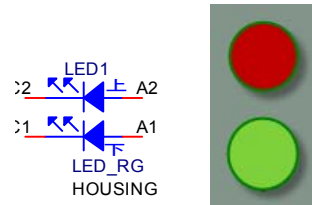

### C. Connector pin definition

Pin	Signal	Location
A1	3.5G_LED_P	Down
C1	3.5G_LED_N	
A2	UPS_LED_P	UP
C2	UPS_LED_N	

---

### 2.13 HDD/ACC LED:

- A. Connector size: 2 Layer LED with Housing
- B. Connector location: LED2

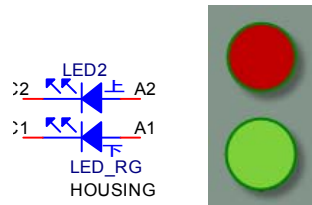

- C. Connector pin definition

Pin	Signal	Location
A1	ACC_LED_P	Down
C1	ACC_LED_N	
A2	HDD_LED_P	UP
C2	HDD_LED_N	

---

---

### (3) Internal connector /pin header specification

#### 3.1 SATA power wafer connector:

- A. Connector size: 1 X 4 = 4 Pin
- B. Connector location: CN1

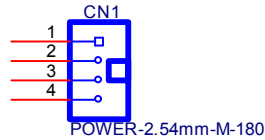

#### C. Connector pin definition

Pin	Signal
1	+5V
2	GND
3	GND
4	+12V

#### 3.2 Reserved JST connector:

- A. Connector size: 2 X 5 = 10 Pin
- B. Connector location: CN2

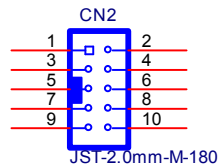

#### C. Connector pin definition

Pin	Signal	Pin	Signal
1	SPI_CLK_GPIO0	2	COM6_TX_GPIO5
3	SPI_CS0_GPIO1	4	COM6_RX_GPIO6
5	SPI_MISO_GPIO2	6	GND
7	SPI_MOSI_GPIO3	8	SCLK0
9	SPI_CSI_GPIO4	10	SDATA0

### 3.3 COM port JST connector:

- A. Connector size: 2 X 5 = 10 Pin
- B. Connector location: COM2

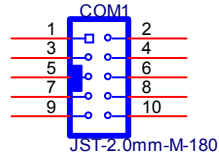

#### C. Connector pin definition

Pin	Signal	Pin	Signal
1	COM4_DCD#	2	COM4_RXD
3	COM4_TXD	4	COM4_DTR#
5	GND	6	COM4_DSR#
7	COM4_RTS#	8	COM4_CTS#
9	COM4_RI#	10	GND

### 3.4 COM port JST connector:

- A. Connector size: 2 X 5 = 10 Pin
- B. Connector location: COM3

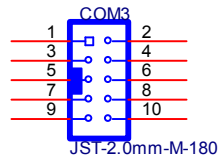

#### C. Connector pin definition (RS-232)

Pin	Signal	Pin	Signal
1	COM2_DCD	2	COM2_RXD
3	COM2_TXD	4	COM2_DTR
5	GND	6	COM2_DSR
7	COM2_RTS	8	COM2_CTS
9	COM2_RI / +5V / +12V	10	GND

#### D. Connector pin definition (RS-422)

Pin	Signal	Pin	Signal
1	COM2_TXD-	2	COM2_TXD+
3	COM2_RXD+	4	COM2_RXD-
5	NC	6	NC
7	NC	8	NC
9	NC	10	NC

E. Connector pin definition (RS-485)

Pin	Signal	Pin	Signal
1	COM2_TXD-/RXD-	2	COM2_TXD+/RXD+
3	NC	4	NC
5	NC	6	NC
7	NC	8	NC
9	NC	10	NC

**3.5 COM port JST connector:**

A. Connector size: 2 X 5 = 10 Pin

B. Connector location: COM4

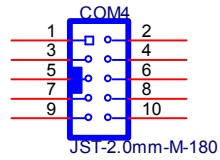

C. Connector pin definition

Pin	Signal	Pin	Signal
1	COM3_DCD	2	COM3_RXD
3	COM3_TXD	4	COM3_DTR
5	GND	6	COM3_DSR
7	COM3_RTS	8	COM3_CTS
9	COM3_RI	10	GND

### 3.6 DVI-D /LVDS connector: (DP0)

A. Connector size: 2 X 20 = 40 Pin

B. Connector location: DVII1

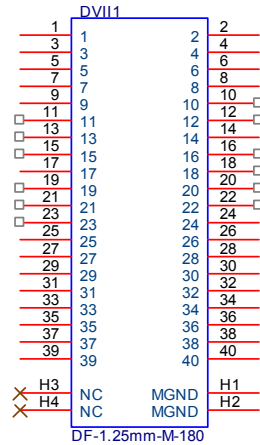

C. Connector pin definition

Pin	Signal	Pin	Signal
1	DVI_TX0_N /LVDS_TX0_N	2	DVI_TX0_P /LVDS_TX0_P
3	DVI_TX1_N /LVDS_TX1_N	4	DVI_TX1_P /LVDS_TX1_P
5	DVI_TX2_N /LVDS_TX2_N	6	DVI_TX2_P /LVDS_TX2_P
7	GND	8	DVI_CLK_N /LVDS_CLK_N
9	DVI_CLK_P /LVDS_CLK_P	10	NC
11	NC	12	NC
13	+5V_DVI_PWR	14	GND
15	+5V_DVI_PWR	16	NC
17	GND	18	NC
19	NC	20	NC
21	+12V_PWR	22	NC
23	+12V_PWR	24	GND
25	GND	26	LVDS_VDD3
27	DVI_DDC_CLK	28	LVDS_VDD5
29	DVI_DDC_DATA	30	LVDS_VDD5
31	DVI_HPD	32	LVDS_VDD12
33	PWRBT#	34	LVDS_PWM
35	LVDS_BLON	36	GND
37	5VSB_USB	38	USB11_P
39	USB11_N	40	GND_USB

### 3.7 VGA JST connector:

A. Connector size: 2 X 8 = 16 Pin

B. Connector location: VGA1

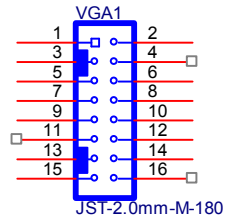

C. Connector pin definition

Pin	Signal	Pin	Signal
1	RED	2	GREEN
3	BLUE	4	NC
5	DET	6	GND
7	GND	8	GND
9	+5V	10	GND
11	NC	12	DAC_SDA
13	HSYNC	14	VSYNC
15	DAC_SCL	16	NC

### 3.8 SATA connector:

A. Connector size: 1 X 7 = 7 Pin (SATA-M-180)

B. Connector location: SATA1

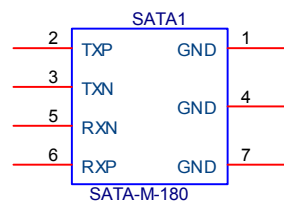

C. Connector pin definition

Pin	Signal
1	GND
2	SATA_TXP1
3	SATA_TXN1
4	GND
5	SATA_RXN1
6	SATA_RXP1
7	GND

### 3.9 SATA connector:

- A. Connector size: SATA-F-22P-90
- B. Connector location: SATA2

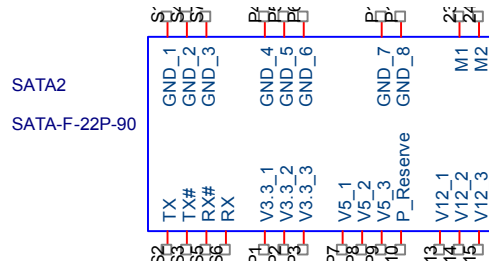

#### C. Connector pin definition

Pin	Signal	Pin	Signal	Pin	Signal
S1	GND	P1	NC	P9	+5V
S2	SATA_TXP0	P2	NC	P10	NC
S3	SATA_TXN0	P3	NC	P11	GND
S4	GND	P4	GND	P12	GND
S5	SATA_RXN0	P5	GND	P13	NC
S6	SATA_RXP0	P6	GND	P14	NC
S7	GND	P7	+5V	P15	
		P8	+5V		

### 3.10 USB JST connector:

- A. Connector size: 2 X 5 = 10 Pin
- B. Connector location: USB5

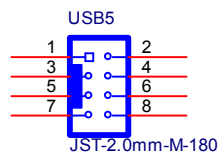

#### C. Connector pin definition

Pin	Signal	Pin	Signal
1	5VSB_USB	2	5VSB_USB
3	USB4_N	4	USB5_N
5	USB4_P	6	USB5_P
7	GND	8	GND



---

---

### 3.11 USB JST connector:

- A. Connector size: 2 X 5 = 10 Pin
- B. Connector location: USB6

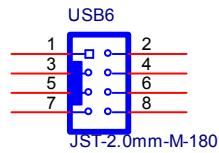

#### C. Connector pin definition

Pin	Signal	Pin	Signal
1	5VSB_USB	2	5VSB_USB
3	USB6_N	4	USB7_N
5	USB6_P	6	USB7_P
7	GND	8	GND

### 3.12 UPS JST connector:

- A. Connector size: 1 X 5 = 5 Pin
- B. Connector location: UPS1

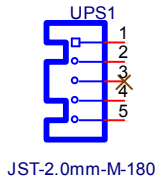

#### C. Connector pin definition

Pin	Signal
1	+12VSB_UPS
2	+12VSB_UPS
3	NC
4	GND
5	GND

---

---

### 3.13 Download Port JST connector:

- A. Connector size: 1 X 5 = 5 Pin
- B. Connector location: J5

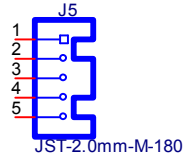

#### C. Connector pin definition

Pin	Signal
1	+3.3V_MCU
2	C2D
3	MRST
4	C2CK
5	GND

### 3.14 BATTERY connector (Recommend to use CR2032 Battery):

- A. Connector size: 1 X 2 = 2 Pin
- B. Connector location: J9

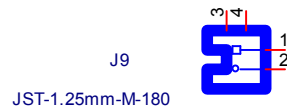

#### C. Connector pin definition

Pin	Signal
1	VBAT
2	GND

---

### 3.15 RTC RESET connector:

A. Connector size: 1 X 3 = 3 Pin

B. Connector location: JP1



JP1  
PIN-2.54mm-M-180

C. Connector pin definition

Pin	Signal
1	RTC_BAT
2	RTCRST#
3	GND

### 3.16 COM2 RS232 RI# Pin Power Select connector:

A. Connector size: 1 X 5 = 5 Pin

B. Connector location: JP5

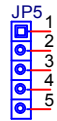

JP5  
PIN-2.0mm-M-180

C. Connector pin definition

Pin	Signal
1	+5V
2	POWER
3	+12V
4	POWER
5	COM2_RI

### 3.17 COM1 RS232 RI# Pin Power Select connector:

- A. Connector size: 1 X 5 = 5 Pin
- B. Connector location: JP7

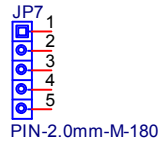

#### C. Connector pin definition

Pin	Signal
1	+5V
2	POWER
3	+12V
4	POWER
5	COM1_RI

### 3.18 MINI CARD connector:

- A. Connector size: 2 X 26 = 52 Pin
- B. Connector location: MINICARD3

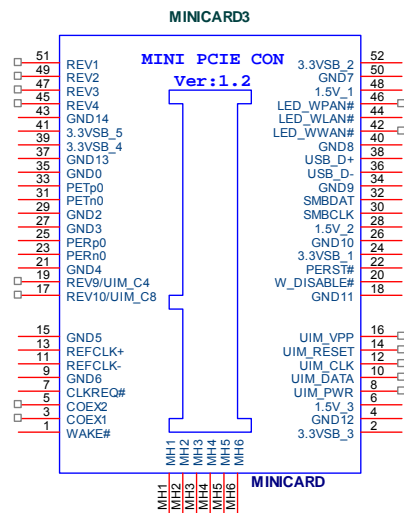

### C. Connector pin definition

Pin	Signal	Pin	Signal
1	PCIE_WAKE#	2	3VSB
3	NC	4	GND
5	NC	6	+1.5V
7	MINICARD0_CLKREQ#	8	NC
9	GND	10	NC
11	PCIE_MCARD0_CLK_N	12	NC
13	PCIE_MCARD0_CLK_P	14	NC
15	GND	16	NC
17	NC	18	GND
19	NC	20	MINICARD0_DIS#
21	GND	22	PCIE_RST#
23	PCIE_MCARD0_RX_N	24	3VSB
25	PCIE_MCARD0_RX_P	26	GND
27	GND	28	+1.5V
29	GND	30	SMB_CLK
31	PCIE_MCARD0_TX_N	32	SMB_DATA
33	PCIE_MCARD0_TX_P	34	GND
35	GND	36	USB_8N
37	GND	38	USB_8P
39	3VSB	40	GND
41	3VSB	42	NC
43	GND	44	NC
45	NC	46	NC
47	NC	48	+1.5V
49	NC	50	GND
51	NC	52	3VSB

### 3.19 MINI CARD connector:

- A. Connector size: 2 X 26 = 52 Pin
- B. Connector location: MINICARD2

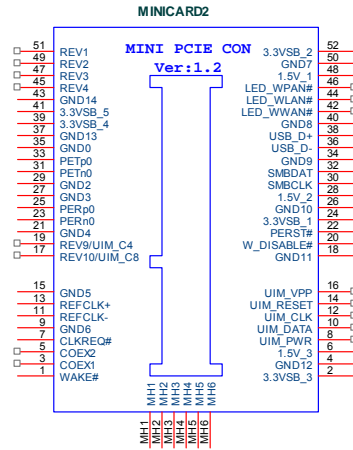

### C. Connector pin definition

Pin	Signal	Pin	Signal
1	PCIE_WAKE#	2	3VSB
3	NC	4	GND
5	NC	6	+1.5V
7	MINICARD1_CLKREQ#	8	NC
9	GND	10	NC
11	PCIE_MCARD1_CLK_N	12	NC
13	PCIE_MCARD1_CLK_P	14	NC
15	GND	16	NC
17	NC	18	GND
19	NC	20	MINICARD0_DIS#
21	GND	22	PCIE_RST#
23	PCIE_MCARD1_RX_N	24	3VSB
25	PCIE_MCARD1_RX_P	26	GND
27	GND	28	+1.5V
29	GND	30	SMB_CLK
31	PCIE_MCARD1_TX_N	32	SMB_DATA
33	PCIE_MCARD1_TX_P	34	GND
35	GND	36	USB_9N
37	GND	38	USB_9P
39	3VSB	40	GND
41	3VSB	42	NC
43	GND	44	NC
45	NC	46	NC
47	NC	48	+1.5V
49	NC	50	GND
51	NC	52	3VSB

### 3.20 MINI CARD connector:

- A. Connector size: 2 X 26 = 52 Pin
- B. Connector location: MINICARD1

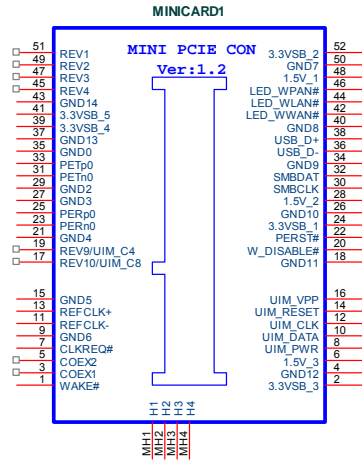

### C. Connector pin definition

Pin	Signal	Pin	Signal
1	PCIE_WAKE#	2	3VSB
3	NC	4	GND
5	NC	6	+1.5V
7	MINICARD2_CLKREQ#	8	UIM_PWR
9	GND	10	UIM_DATA
11	PCIE_MCARD2_CLK_N	12	UIM_CLK
13	PCIE_MCARD2_CLK_P	14	UIM_RST
15	GND	16	UIM_VPP
17	NC	18	GND
19	NC	20	MINICARD0_DIS#
21	GND	22	PCIE_RST#
23	PCIE_MCARD2_RX_N	24	3VSB
25	PCIE_MCARD2_RX_P	26	GND
27	GND	28	+1.5V
29	GND	30	SMB_CLK
31	PCIE_MCARD2_TX_N	32	SMB_DATA
33	PCIE_MCARD2_TX_P	34	GND
35	GND	36	USB_10N
37	GND	38	USB_10P
39	3VSB	40	GND
41	3VSB	42	3.5G_LED_WWAN#
43	GND	44	3.5G_LED_WAN#
45	NC	46	3.5G_LED_WPAN#
47	NC	48	+1.5V
49	NC	50	GND
51	NC	52	3VSB

# 4 System Installation

## 4.1 System Introduction

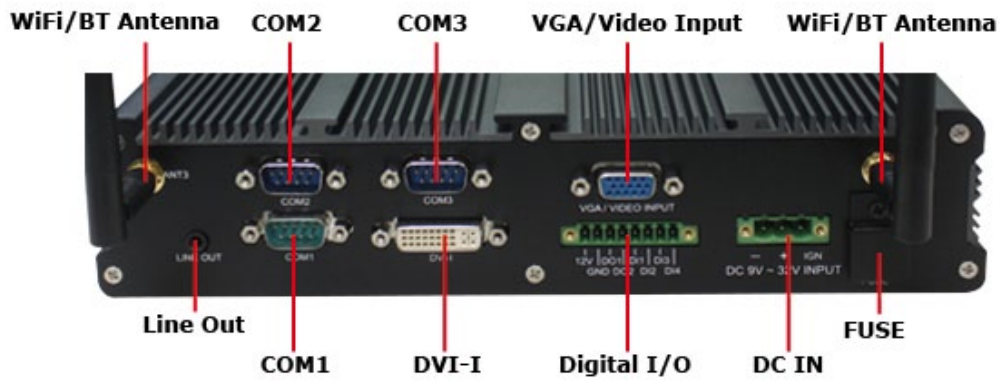
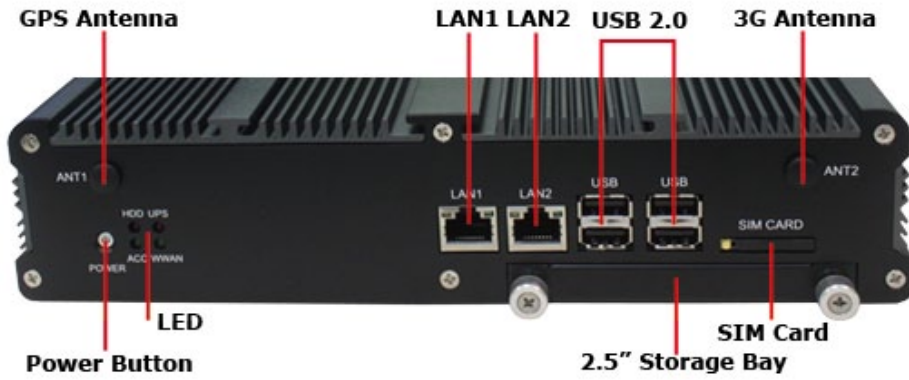



## ■ 4.2 Opening Chassis

**Step 1.** Unscrew the six screws of the Back Cover as shown in the picture.

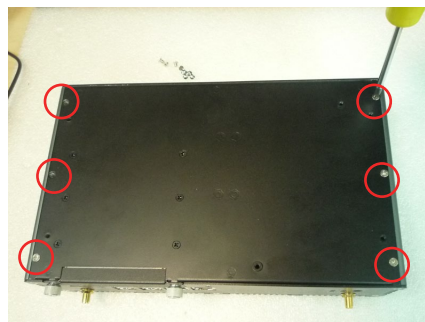

**Step 2.** Unscrew the six screws of the Front Panel as shown in the picture.



**Step 3.** Unscrew the six screws of the Rear Panel as shown in the picture.

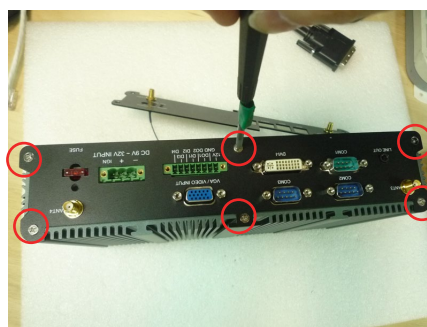

**Step 4.** Open Top Cover as shown in the picture.



**Step 5.** You can see three connectors connect with mainboard as shown in the picture.

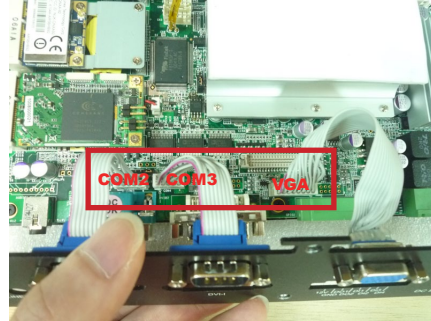

**Step 6.** Pull up the connector as shown in the picture.

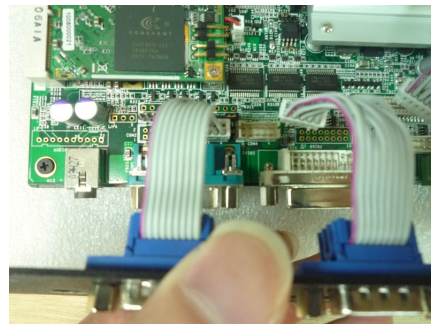

**Step 7.** You can see Ipex on the Mini PCIe module connectors as shown in the picture.

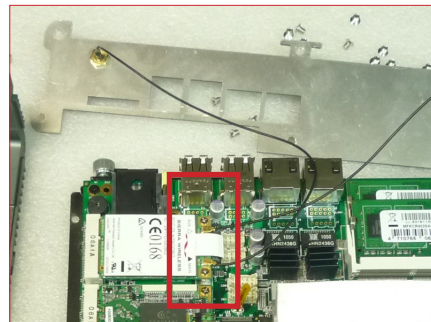

**Step 8.** Pull up the Ipex as shown in the picture.



### ■ 4.3 Installing Memory

**Step 1.** Put Memory on this place as shown in the picture.

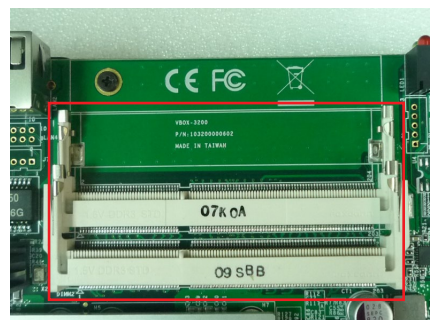

**Step 2.** Hold the Memory with its notch aligned with the Memory socket of the board and insert it at a 30-degree angle into the socket as shown in the picture.



**Step 3.** Fully insert the module into the socket until a “click” is heard as shown in the picture.



**Step 4.** Press down on the Memory so that the tabs of the socket lock on both sides of the module.

**Step 5.** Hold the Memory with its notch aligned with the Memory socket of the board and insert it at a 30-degree angle into the socket as shown in the picture.



**Step 6.** Fully insert the module into the socket until a “click” is heard as shown in the picture.



**Step 7.** Press down on the Memory so that the tabs of the socket lock on both sides of the module as shown in the picture.



## ■ 4.4 Installing MINI PCIe Expansion Card (PCIe 1)

**Step 1.** Put MINI PCIe Expansion Card on this place as shown in the picture.

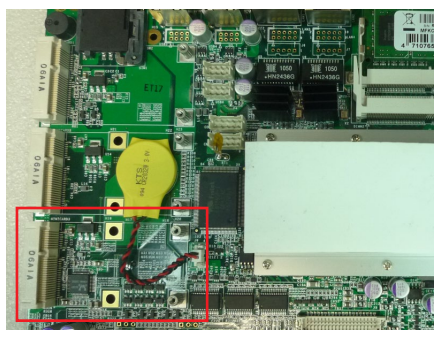

**Step 2.** Hold the Module with its notch aligned with the socket of the board and insert it at a 30 degree angle into the socket as shown in the picture.

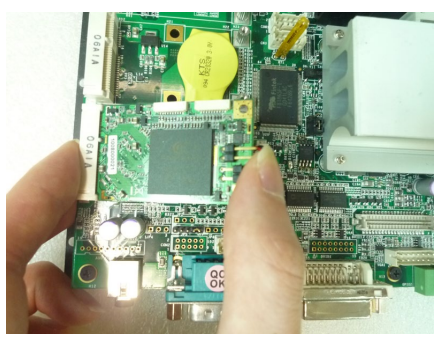

**Step 3.** Screw two screws to the holder as shown in the picture.



**Step 4.** Done as shown in the picture.

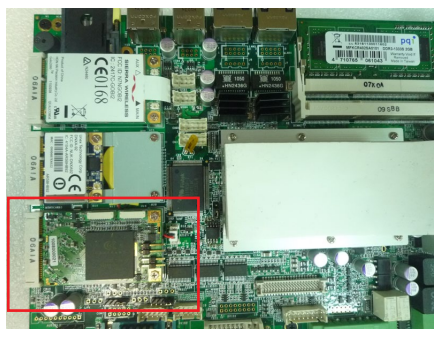

## ■ 4.5 Installing MINI PCIe Expansion Card (PCIe 2, Wifi Module)

**Step 1.** Put MINI PCIe Expansion Card on this place as shown in the picture.

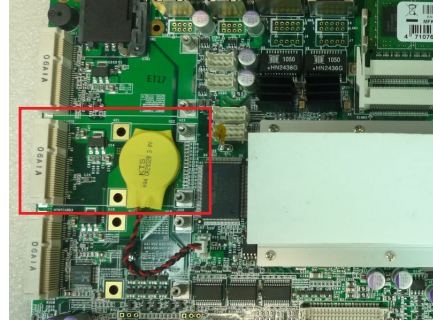

**Step 2.** Hold the Module with its notch aligned with the socket of the board and insert it at a 30 degree angle into the socket as shown in the picture.



**Step 3.** Screw two screws to the holder as shown in the picture.



**Step 4.** Done as shown in the picture.

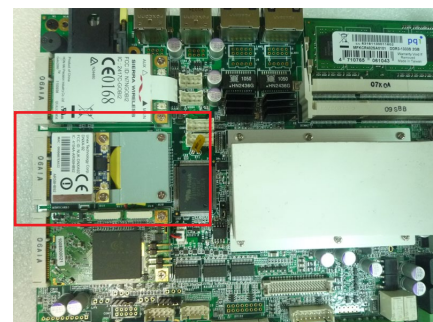

## ■ 4.6 Installing MINI PCIe Expansion (PCIe 3, 3G Module only)

**Step 1.** Put MINI PCIe Expansion Card on this place as shown in the picture.

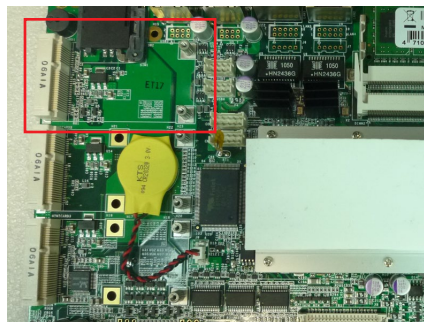

**Step 2.** Hold the Module with its notch aligned with the socket of the board and insert it at a 30 degree angle into the socket as shown in the picture.



**Step 3.** Screw two screws to the holder as shown in the picture.



**Step 4.** Done as shown in the picture.

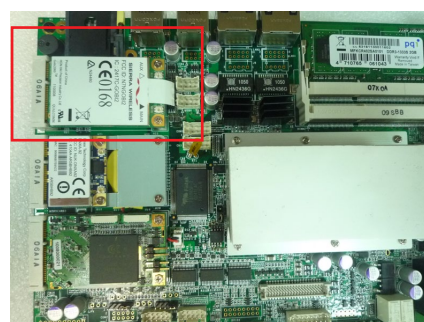

## ■ 4.7 Installing Internal Antenna Cable

**Step 1.** Take the SMA Connector and Plug into IO Panel as shown in the picture.

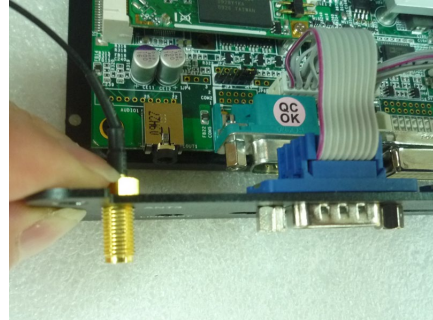

**Step 2.** Put the Washer into the SMA Connector as shown in the picture.



**Step 3.** Put the Oring to SMA Connector and tighten as shown in the picture.

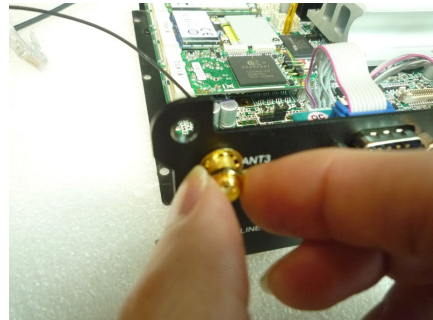

**Step 4.** Done as shown in the picture.





**Step 5.** Take the Ipex Connector and press on the wifi module as shown in the picture.(Wifi)

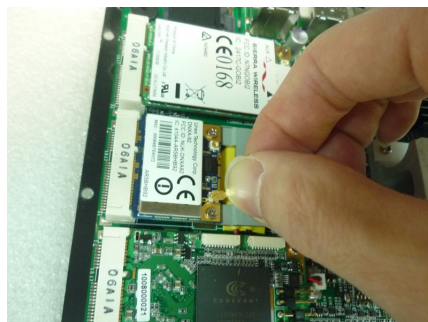

**Step 6.** Take the Ipex Connector and press on the 3G module as shown in the picture. (3G)



**Step 7.** Take the Ipex Connector and press on the GPS module as shown in the picture. (GPS, only support passive Antenna)



## ■ 4.8 Installing SIM Card

**Step 1.** Use thin stick to push the button as shown in the picture.



**Step 2.** Take the holder away from the device as shown in the picture.



**Step 3.** Put your SIM Card into the holder as shown in the picture.



**Step 4.** Take the SIM card holder and insert it into the socket as shown in the picture.



## 4.9 Installing HDD

**Step 1.** Put the HDD into HDD Holder as shown in the picture.



**Step 2.** Screw two screws on both side as shown in the picture.



**Step 3.** Push the HDD Holder into the socket as shown in the picture.



**Step 4.** Fully insert the HDD Holder into the socket until a “click” is heard as shown in the picture.



**Step 5.** Tighten to Storage Bracket screws as shown in the picture.



---

---

## (5) System Resources

### 5.1 Ignition Power Management Quick Guide

#### Startup/shutdown conditions from the IGNITION signal:

- IGNITION startup signal must be valid during 5 sec. (anti noise protection).
- IGNITION shutdown – IGNITION signal must be inactive during 5 minutes, then PIC controller initiate Power Button signal (OS must be set to shutdown from the Power Button). It generate Main Button shutdown event and then goes to complete power off.

Typically the system can start only from IGNITION signal, because startup PIC controller is disconnected from the power source.

The system can be switched off from:

- Power IGNITION OFF signal.
- ACPI OS shutdown
- Power Button – generate ACPI event (OS dependent).



#### Power Ignition Startup Procedure

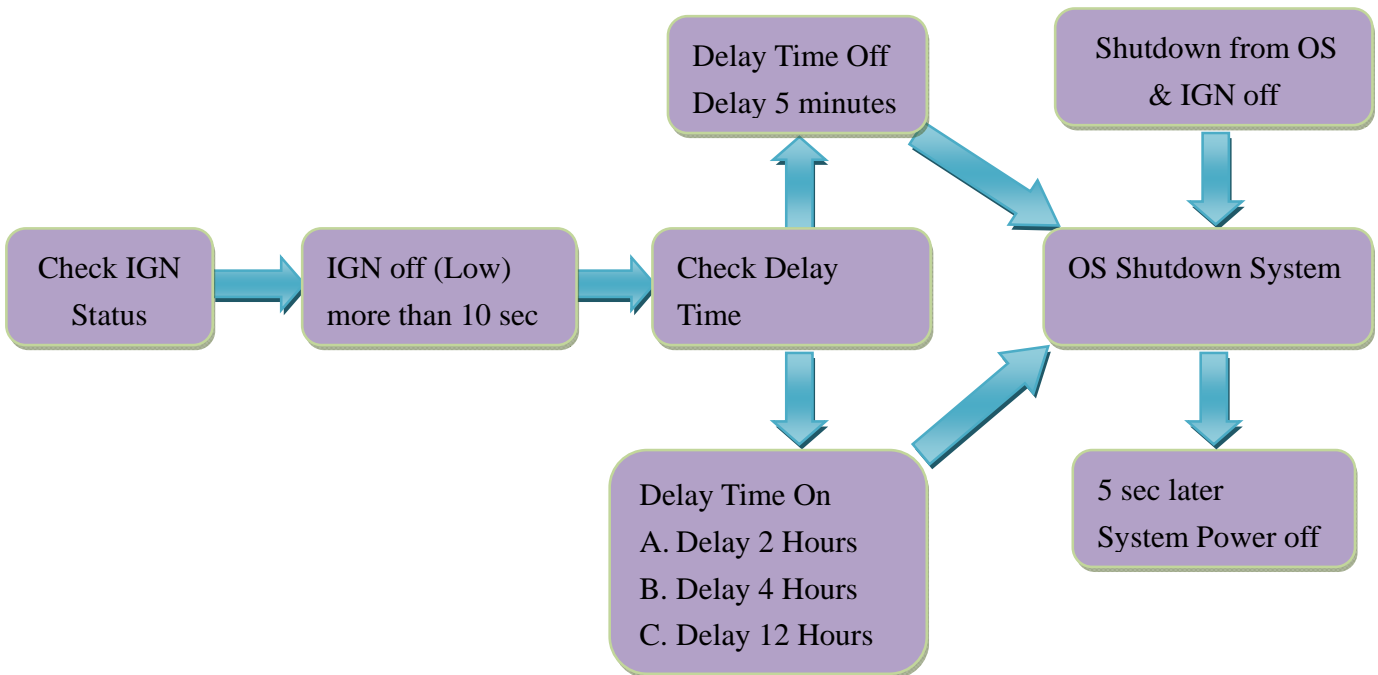

### Power Ignition Shutdown Procedure

#### Power Management

- Power-off delay time is selectable by BIOS to disable and enable in 5 min / 2hr / 4hr / 12hr
- Ignition On/Off status detectable by SW
- If the ignition is off and the system is still on after 5 minutes, FleetPC-5 will shut down automatically.
- If the ignition is turned on again and the power-off delay is in progress, FleetPC-5 will cancel the delay function and will continue to operate normally.
- If the ignition is turned on again and the power-off delay ended, FleetPC-5 will shut down completely will power-on again automatically.

## 5.2 GPIO & Delay Time Setting

### 5.2.1 GPIO, Delay Time and Ignition Control Register

The General Purpose I/O is an interface available on some devices. These can read digital signals from other parts of a circuit, or output to control other devices. At GPIO control register, the GPI is use to receive data, the GPO is set data to send.

**I/O port:** Read A2h / Write A1h

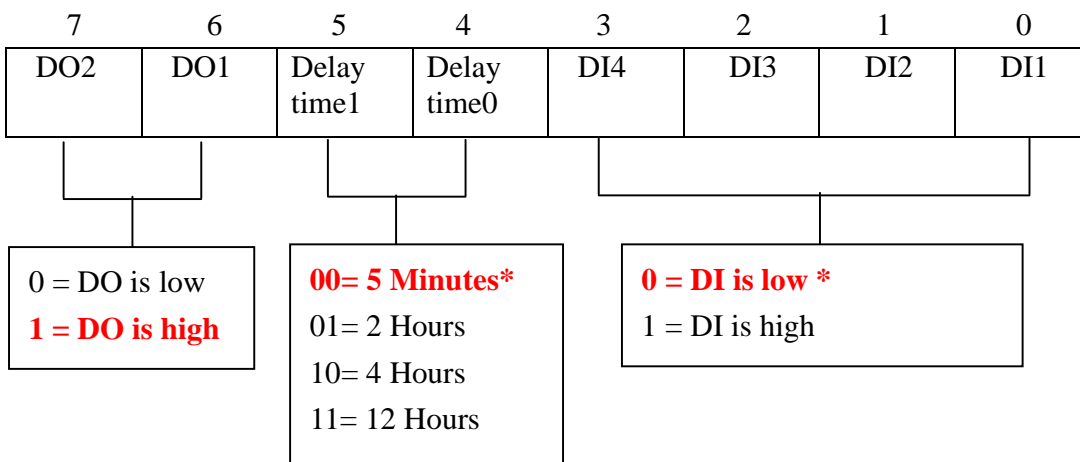

**I/O port:** D2h

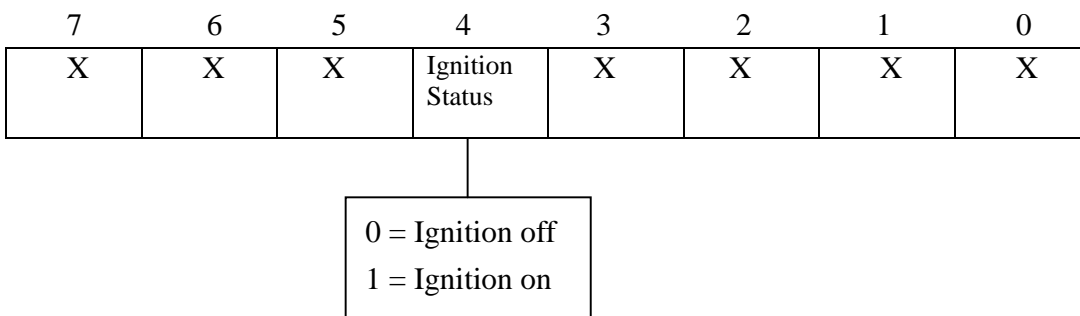

---

## Read Ignition Register & Example Code

```
if (pFunc != IntPtr.Zero)
{
    UInt32 PortVal;
    SetPortValType SetPortVal = (SetPortValType)Marshal.GetDelegateForFunctionPointer(pFunc,
    typeof(SetPortValType));
    GetPortValType GetPortVal = (GetPortValType)Marshal.GetDelegateForFunctionPointer(pFunc,
    typeof(GetPortValType));

    SetPortVal(0x4E, 0x87, 1); // Enter Super IO
    SetPortVal(0x4E, 0x87, 1); // Enter Super IO
    SetPortVal(0x4E, 0x07, 1); // Select Logic 7 for GPIO
    SetPortVal(0x4F, 0x06, 1);
    SetPortVal(0x4E, 0xD2, 1); // Ignition Status Register bit4
    // Call WinIo to get value
    bool Result1 = GetPortVal(0x4F, &PortVal, 1); // Read GPIO Status
    SetPortVal(0x4E, 0xAA, 1); // exit PNP mode
}
```

### 5.2.2 GPIO Programming Procedure

< // C# use Winio >

#### (1) Write Register & Example Code

```
IntPtr pFunc = GetProcAddress(hMod, "SetPortVal");
if (pFunc != IntPtr.Zero)
{
    SetPortValType SetPortVal = (SetPortValType)Marshal.GetDelegateForFunctionPointer(pFunc,
    typeof(SetPortValType));

    SetPortVal(0x4E, 0x87, 1); // Enter Super IO
    SetPortVal(0x4E, 0x87, 1); // Enter Super IO
    SetPortVal(0x4E, 0x07, 1); // Select Logic 7 for GPIO
    SetPortVal(0x4F, 0x06, 1); //
    SetPortVal(0x4E, 0xA1, 1); // Set GPIO 5X Address
    SetPortVal(0x4F, 0xF0, 1); // Set GPO 0~3 value = "0" means output is low
    SetPortVal(0x4E, 0xAA, 1); // exit PNP mode
}
```



---

---

## (2) Read Register & Example Code

```
if (pFunc != IntPtr.Zero)
{
    UInt32 PortVal;
    SetPortValType SetPortVal = (SetPortValType)Marshal.GetDelegateForFunctionPointer(pFunc,
    typeof(SetPortValType));
    GetPortValType GetPortVal = (GetPortValType)Marshal.GetDelegateForFunctionPointer(pFunc,
    typeof(GetPortValType));
    SetPortVal(0x4E, 0x87, 1); // Enter Super IO
    SetPortVal(0x4E, 0x87, 1); // Enter Super IO
    SetPortVal(0x4E, 0x07, 1); // Select Logic 7 for GPIO
    SetPortVal(0x4F, 0x06, 1);
    SetPortVal(0x4E, 0xA2, 1); // GPIO Status Register
    // Call WinIo to get value
    bool Result1 = GetPortVal(0x4F, &PortVal, 1); // Read GPIO Status
}
```

### 5.2.3 WDT Setting

**I/O port:** 260 (base address) + 05h and 06h

#### 1 Watchdog Timer Control Register

The Watchdog Timer Control Register controls the WDT working mode. Write the value to the WDT Configuration Port. The following table describes the Control Register bit definition:

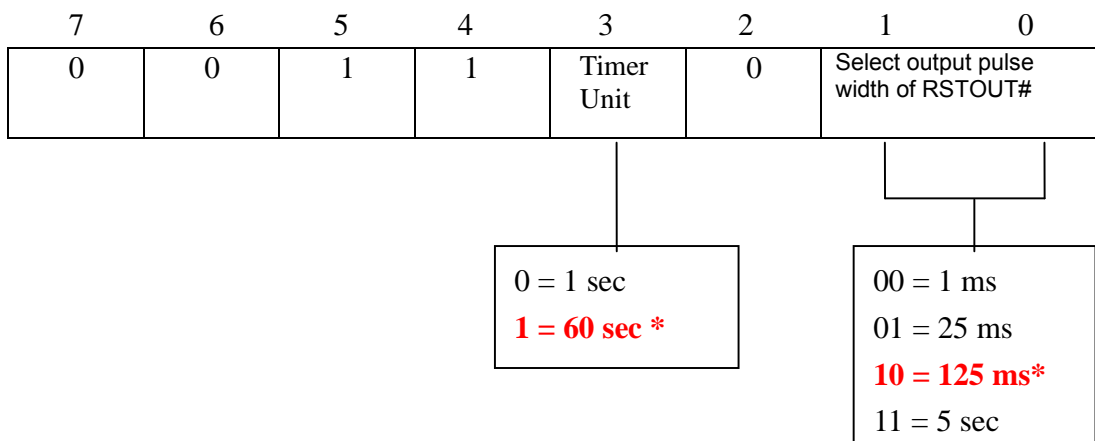

## 7.9. Watchdog Timer Function

Watch dog timer is provided for system controlling. If time-out can trigger one signal to high/low level/pulse, the signal is depend on register setting.

The time unit has two ways from 1sec or 60sec. In pulse mode, there are four pulse widths can be selected (1ms/25ms/125ms/5sec). Others, please refer the device register description as below.

### Watchdog Timer Configuration Register 1— base address + 05h

Bit	Name	R/W	Default	Description
7	Reserved	R	0	Reserved
6	WDTMOUT_STS	R/W	0	If watchdog timeout event occurs, this bit will be set to 1. Write a 1 to this bit will clear it to 0.

5	WD_EN	R/W	0	If this bit is set to 1, the counting of watchdog time is enabled.
4	WD_PULSE	R/W	0	Select output mode (0: level, 1: pulse) of RSTOUT# by setting this bit.
3	WD_UNIT	R/W	0	Select time unit (0: 1sec, 1: 60 sec) of watchdog timer by setting this bit.
2	WD_HACTIVE	R/W	0	Select output polarity of RSTOUT# (1: high active, 0: low active) by setting this bit.
1-0	WD_PSWIDTH	R/W	0	Select output pulse width of RSTOUT# 0: 1 ms                    1: 25 ms 2: 125 ms                3: 5 sec

### Watchdog Timer Configuration Register 2 — base address + 06h

Bit	Name	R/W	Default	Description
7-0	WD_TIME	R/W	0	Time of watchdog timer

### Watchdog PME Control Register — base address + 0Ah

Bit	Name	R/W	Default	Description
7	WDT_PME	R	--	The PME Status. This bit will set when WDT_PME_EN is set and the watchdog timer is 1 unit before time out (or time out).
6	WDT_PME_EN	R/W	0	0: Disable Watchdog PME. 1: enable Watchdog PME.
5-1	Reserved	--	--	Reserved.
0	WDOUT_EN	R/W	0	0: disable Watchdog time out output via WDTRST#. 1: enable Watchdog time out output via WDTRST#.

---

## 2 Watchdog Timer Programming Procedure

### (1) Example Code

```
private void button2_Click(object sender, EventArgs e)
{
    IntPtr pFunc = GetProcAddress(hMod, "SetPortVal");
    if (pFunc != IntPtr.Zero)
    {
        SetPortValType SetPortVal = (SetPortValType)Marshal.GetDelegateForFunctionPointer(pFunc,
typeof(SetPortValType));
        SetPortVal(0x266, 0x0A, 1); // Set watchdog timer value is 10
        SetPortVal(0x265, 0x32, 1); // Set watchdog timer unit is sec and enable watchdog
        // SetPortVal(0x265, 0x3A, 1); // Set watchdog timer unit is minuates and enable watchdog
    }
}
```

---

---

## 5.3 Gobi2000 WWAN Module Application Note

Document Number: FleetPC-5-WWAN-01

### 1. EQUIPMENT REQUIREMENTS

### 2. TEST SETUP

### 3. TEST

### 4. PASS/FAIL CRITERIA :

#### 1. EQUIPMENT REQUIREMENTS

- Sierra Wireless Gobi 2000.
- FETnet 3G SIM Card with HSDPA operation.

#### 2. TEST SETUP

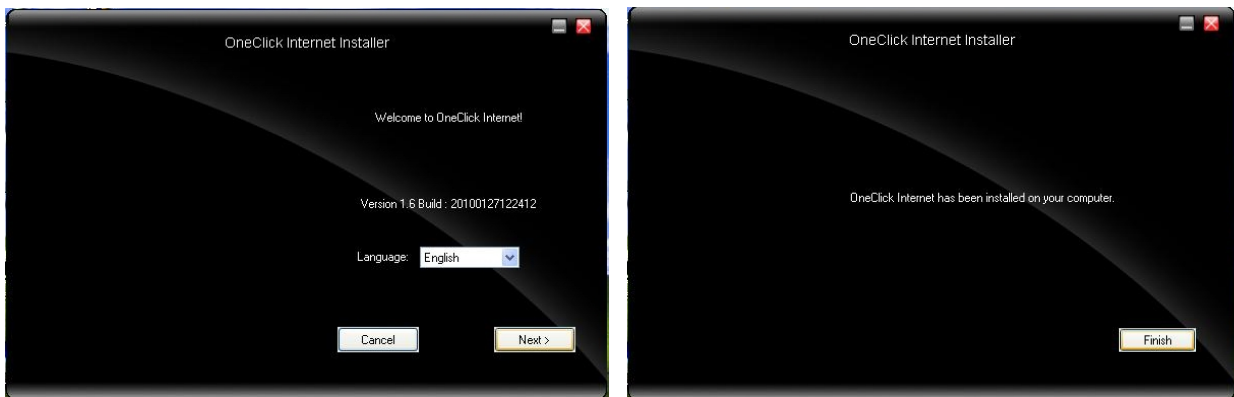

Figure 1: Install WWAN AP

Install WWAN AP and configure the EUT with the latest hardware and software. Place EUT in the test environment, and check the signal of the WWAN module should be as high as possible. Setup all appropriate test equipment for performing this test.



**Figure 2:** Signal of WWAN Module for UTMS Channels.

### 3. TEST Procedure

Power-up the EUT until it has completed its boot up process. Place the EUT in building and check the UMTS/HSDPA signal intensity. Connect to Internet through UMTS/HSDPA channel. Check the link speed if bandwidth is 7.2Mbps. Download a 10Mbytes test file from Internet. Record the results from the link states. Make sure it has no any error while downloading.

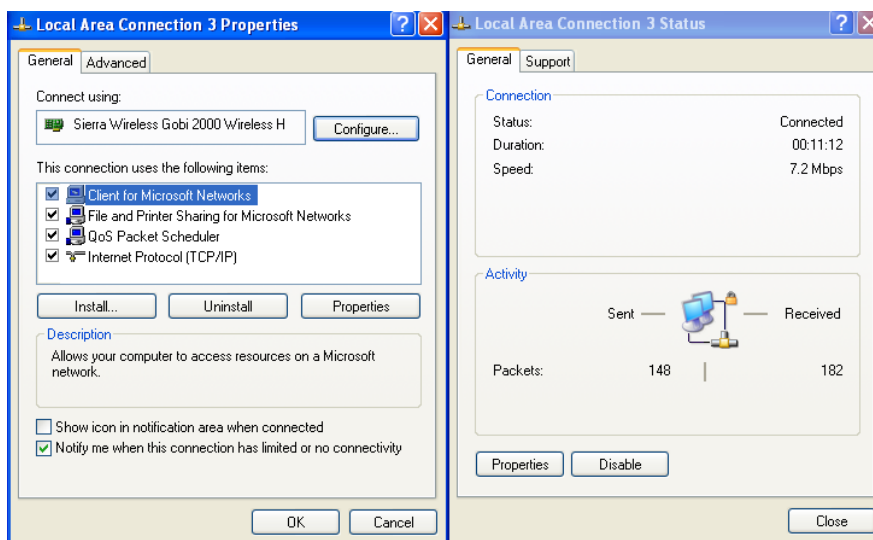

**Figure 3:** Link Speed of WWAN Module for UMTS/HSDPA Channels.

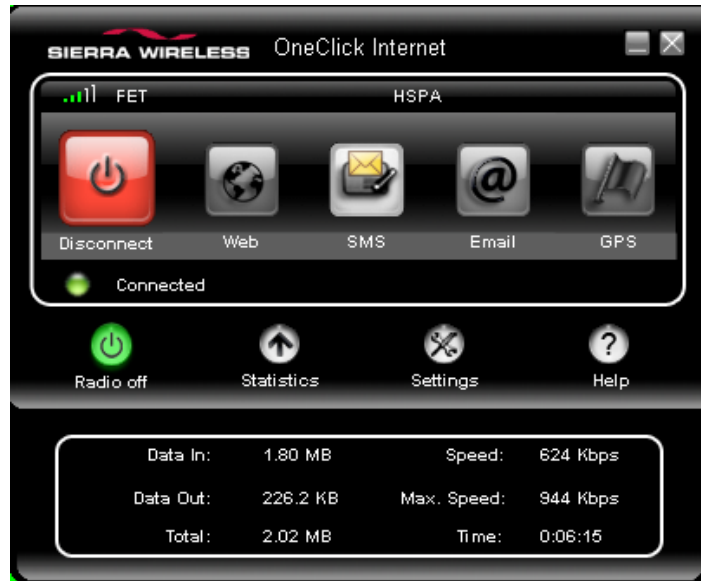

Figure 4: Link State of WWAN Module.

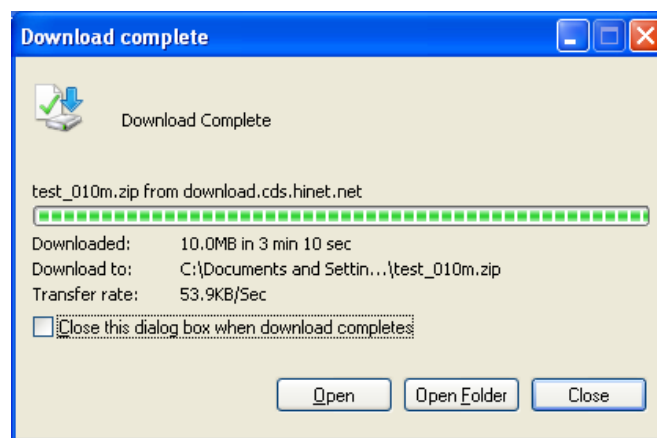
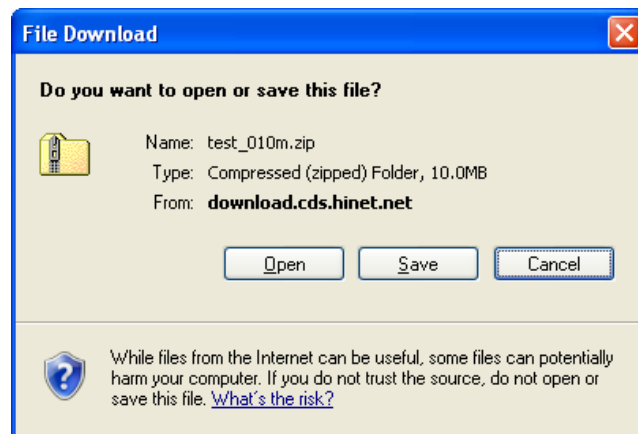

Figure 5: Download Test File from Internet.

---

#### 4. PASS/FAIL CRITERIA :

**PASS Criterion :** The signal intensity item of the WWAN module must greater than 3 steps. And download test no any error.

Signal intensity item

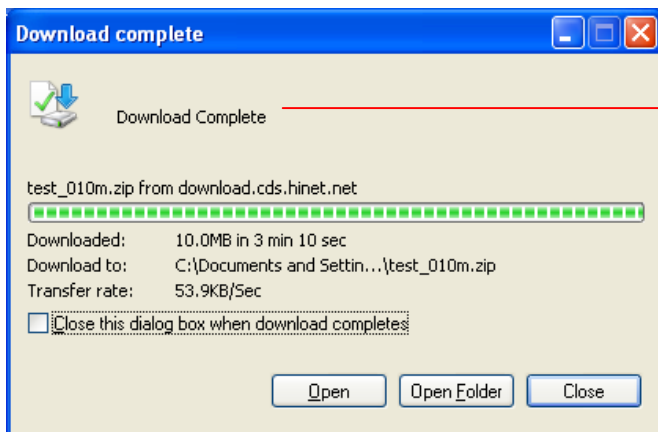
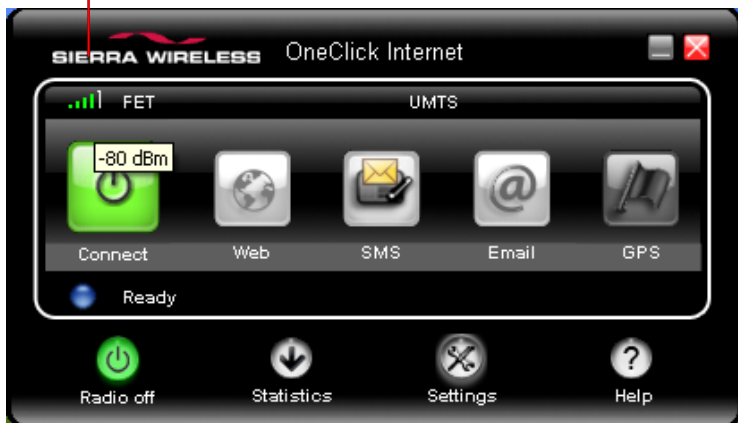

Download complete and no any error

---

---

## 5.4 Gobi2000 GPS Module Application Note

Document Number: FleetPC-5-GPS-01

### 1. EQUIPMENT REQUIREMENTS

### 2. TEST SETUP

### 3. TEST

### 4. PASS/FAIL CRITERIA :

### 5. EQUIPMENT REQUIREMENTS

- Sierra Wireless Gobi 2000.
- FETnet 3G SIM Card with HSDPA operation.
- GPSview program.

### 6. TEST SETUP

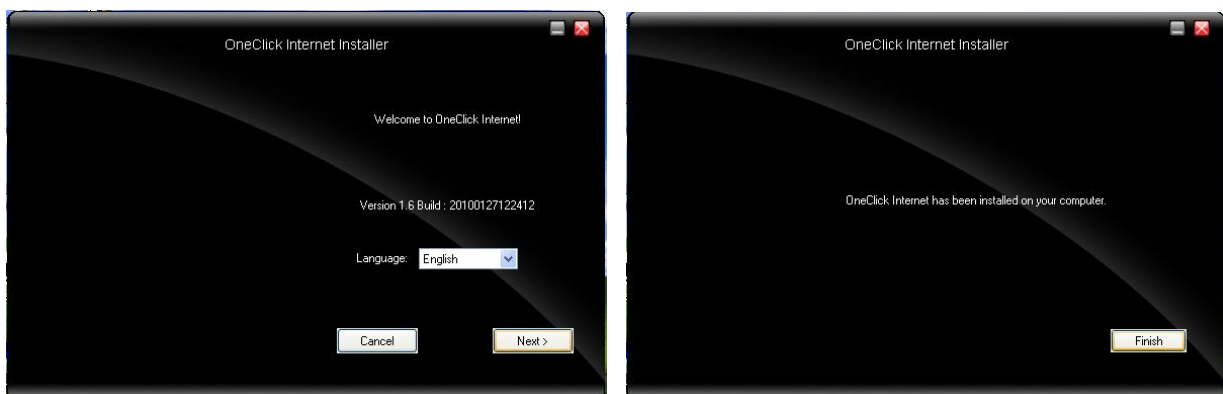

Figure 1: Install WWAN AP

Install WWAN AP and configure the EUT with the latest hardware and software. Place EUT in the test environment, and check the signal of the WWAN module should be as high as possible. Setup all appropriate test equipment for performing this test.

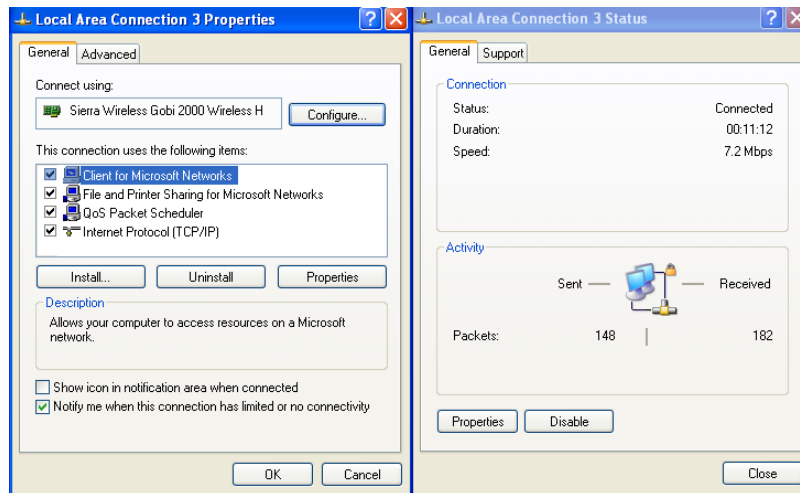



**Figure 2:** Signal of WWAN Module for UTMS Channels.

## 7. TEST

Out door power-up the EUT until it has completed its boot up process. Place the EUT in building and check the UMTS/HSDPA and GPS signal intensity. Get GPS longitude and latitude; connect to Internet through UMTS/HSDPA channel. Check Google Maps and GPSview satellite set and fix time.



**Figure 3:** Link Speed of WWAN Module for UMTS/HSDPA Channels.

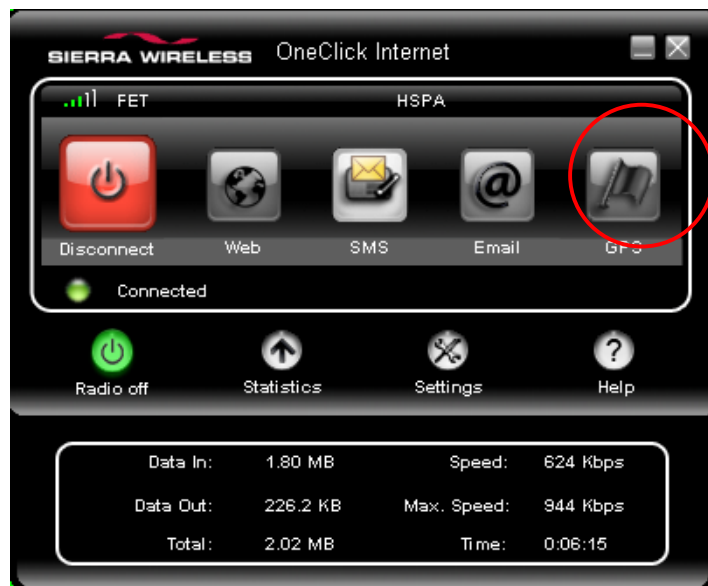

**Figure 4:** Link State of WWAN Module.



**Figure 5:** GPS longitude and latitude information.

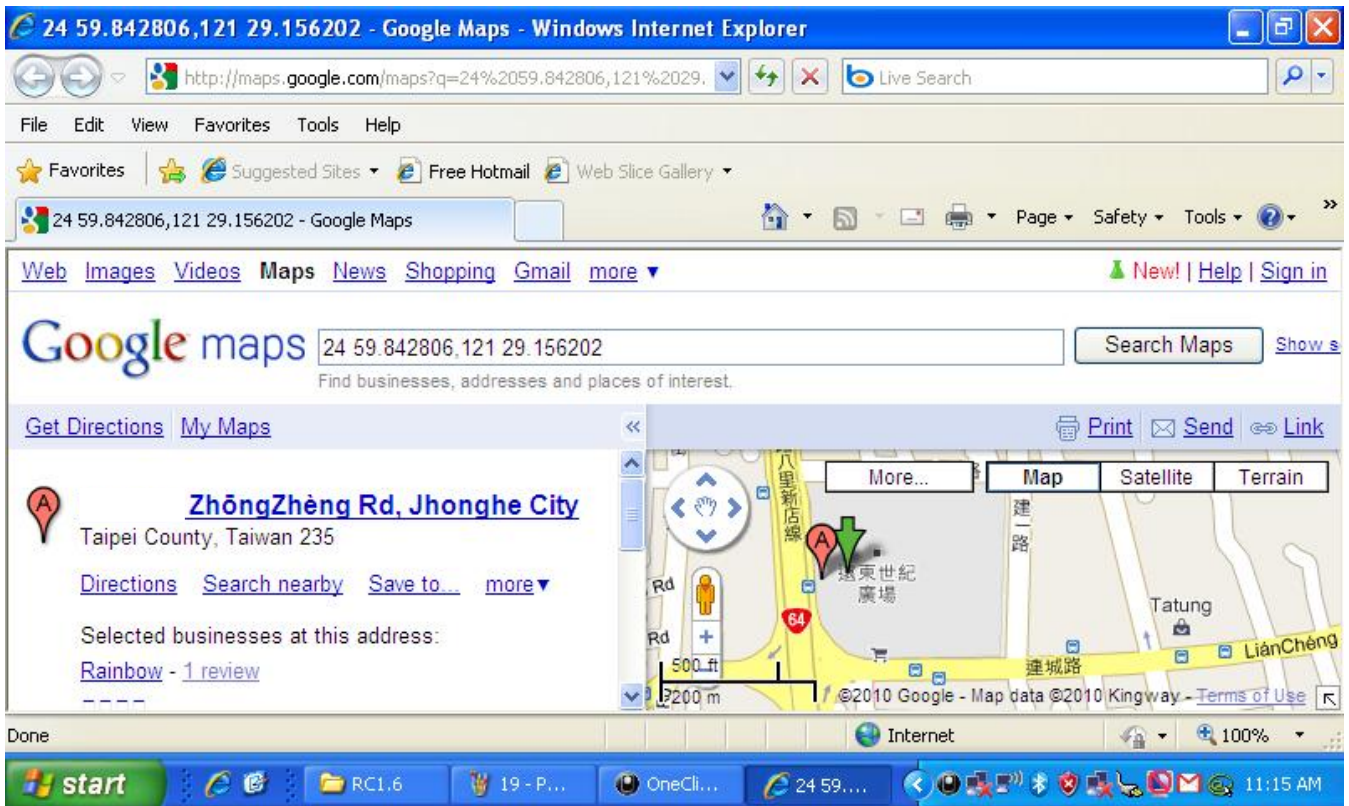

Figure 6: Link to Google Maps.

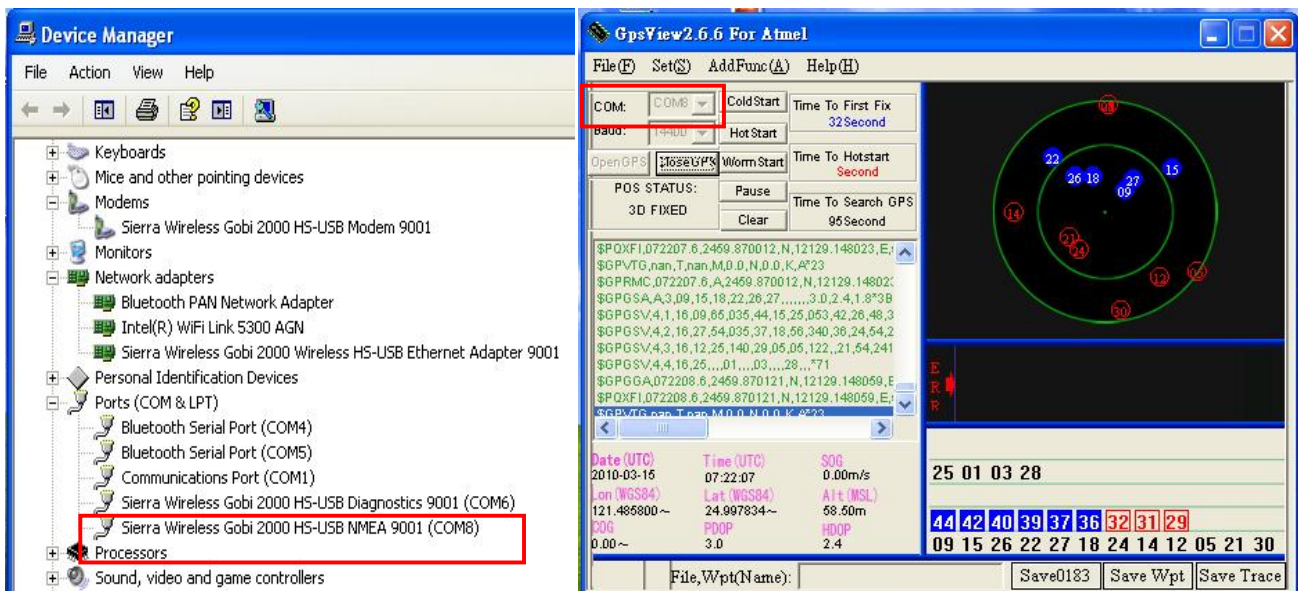

Figure 7: Gpsview program test.

## 8. PASS/FAIL CRITERIA :

### PASS Criterion :

We must check two results. One is amount of satellite, and another one is the satellite set and fix time.

The amount of satellite must exceed five satellites, and the intensity must exceed 30.

The satellite set and fix time must be smaller than 60 sec.

satellite set and fix time

The screenshot shows the GpsView2.6.6 For Atmel software interface. The window title is "GpsView2.6.6 For Atmel". The interface includes a menu bar (File, Set, AddFunc, Help), a control panel with buttons for "Cold Start", "Hot Start", "Worm Start", "Pause", and "Clear", and a "POS STATUS:" section showing "3D FIXED". The main display area shows a circular plot of satellites with numbers 14, 15, 18, 22, 23, 24, 26, 27, 29, 30, and 32. Below the plot, there is a data table with columns for "Date (UTC)", "Time (UTC)", "SOG", "Lon (WGS84)", "Lat (WGS84)", "Alt (MSL)", "COG", "PDOP", and "HDOP". The data row shows: Date (UTC) 2010-03-15, Time (UTC) 07:22:07, SOG 0.00m/s, Lon (WGS84) 121.485800~, Lat (WGS84) 24.997834~, Alt (MSL) 58.50m, COG 0.00~, PDOP 3.0, HDOP 2.4. Below the data table, there are two rows of satellite data: "44 42 40 39 37 36 32 31 29" and "89 15 26 22 27 18 24 14 12 05 21 38". The "Time To First Fix" is 32Second, "Time To Hotstart" is Second, and "Time To Search GPS" is 95Second. The bottom of the window has buttons for "File, Wpt(Name):", "Save0183", "Save Wpt", and "Save Trace".

amount of satellite and intensity

---

## (6) BIOS

### 6.1 Super IO Configuration

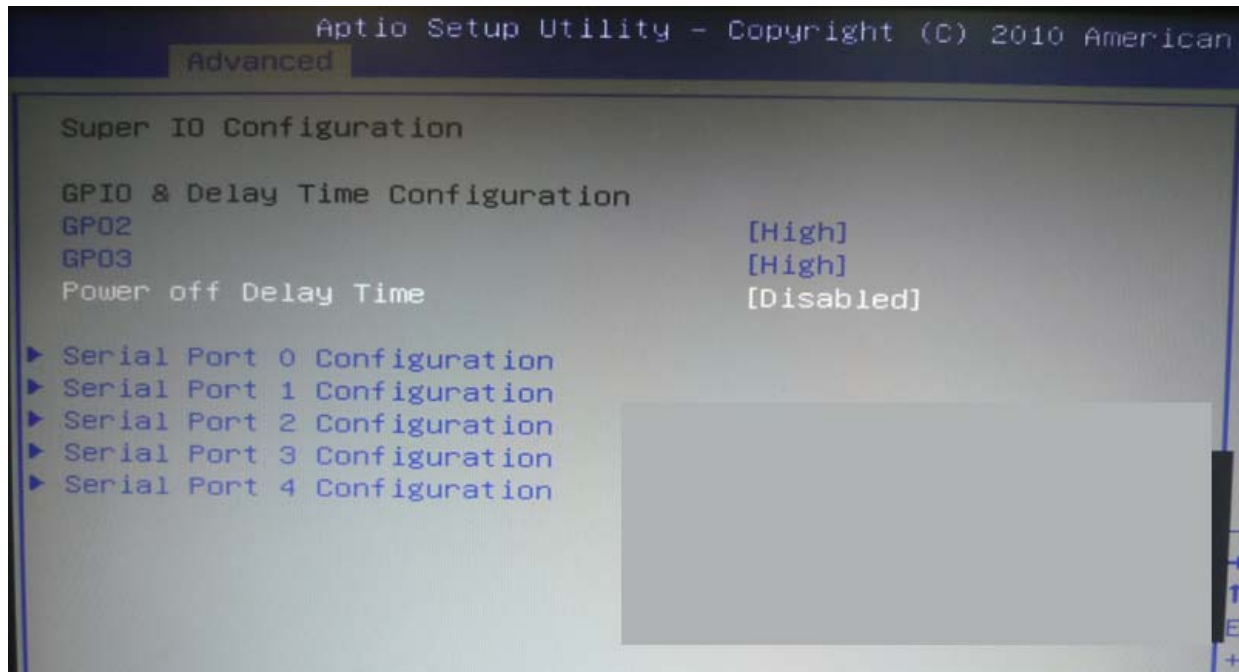

Select Serial Port Mode

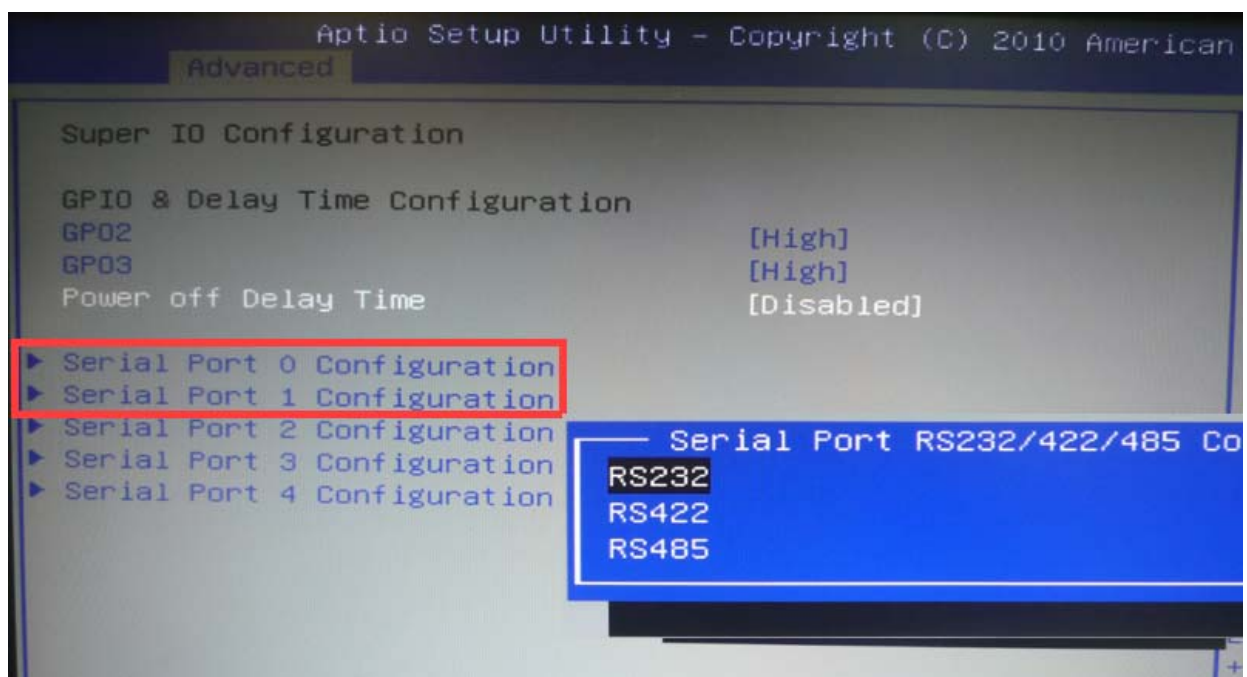

---

Select Power off delay time

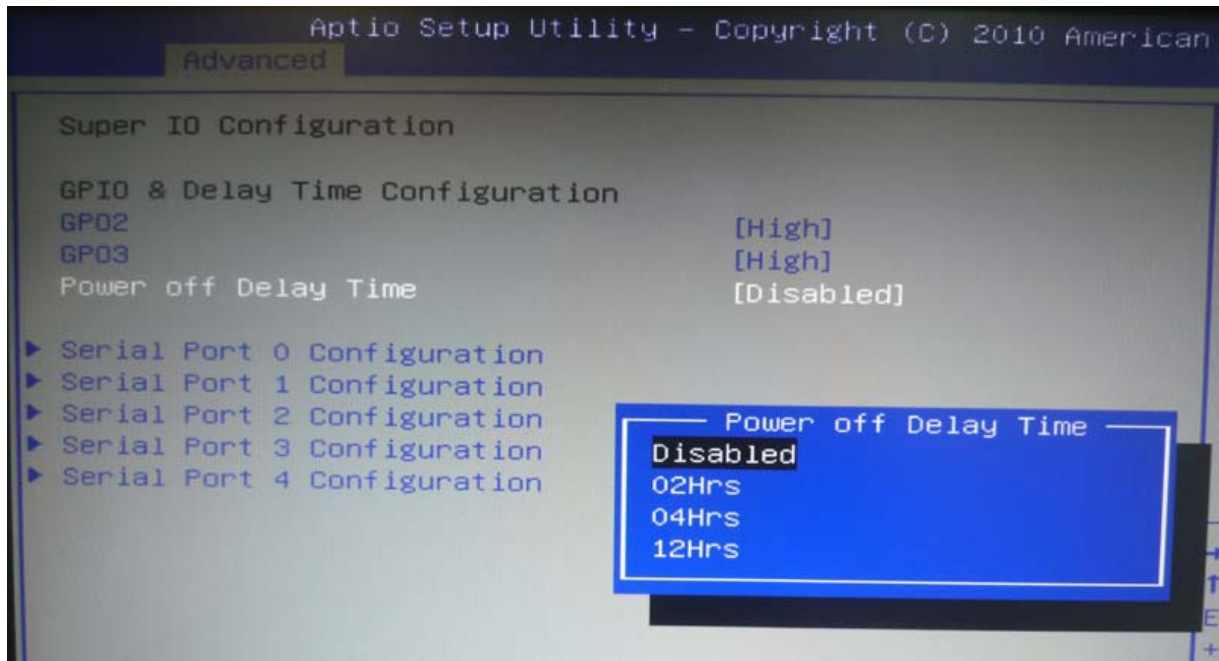

## (7) Packing List

### 7.1 Packing List

Item	Part Number	Module Name
1	663200001000	FleetPC-5-T56N/2GB
2	370832001100	FleetPC-5 Mount Bracket
3	351102040110	Screw I Type M2*4L ISO NI
4	351103040250	Screw F Type M3*4
7	324610088661	CABLING PHOENIX CON MALE 8PIN

#### Optional

Memory	514001105300	APACER	APACER 1GB SO-DIMM DDR3 1333 204pin
Memory	514002105000	PQI	SODIMM 78.02GC6.420 (EL) APACER 2GB SO-DIMM DDR3 1333 204pin
HDD	521340012200	WD	SODIMM (HY) 160GB SATA HDD / 5400/8MB/12ms , 9.5mm
HDD	521370012200	WD	WD1600BEVT 320GB SATA HDD / 5400/8MB/12ms , 9.5mm
2.5" SSD	522130012030	APACER	WD3200BEVT 8GB SSD (SLC Type) AP-SAFD254QA008GS-HT
2.5" SSD	523400002000	Intel	40GB SSD (MLC Type) X25V
2.5" SSD	523410002000	Intel	SSDSA2MP040G2K5 80GB SSD (MLC Type) SSDSA2MH080G2K5
2.5" SSD	523340002000	Intel	160GB SSD (MLC Type) SSDSA2MH160G2K5
SATA DOM	534002150400	APACER	2GB SATA DOM(SLC Type) 7P/270D
SATA DOM	534004150400	APACER	AP-SDM002G8LASS-J 4GB SATA DOM(SLC Type)
SATA DOM	534008150400	APACER	7P/270D AP-SDM004G8LADS-KS 8GB SATA DOM(SLC Type)
3G / GPS	573000011090	Gobi2000	7P/270D AP-SDM008G8LASS-KT HSPA/UMTS –800/850/900/1900/2100MHz
			Quad-band EDGE/GPRS/GSM –850/900/1800/1900MHz Dual-band EV-DO/CDMA –800/1900MHz GPS is Standalone, gpsOne XTRA assistance for enhanced standalone GPS performance, MS-based assisted (support varies based on network carrier)

---



---

WiFi /BT	570802090040	QCOM	Ralink(RT3090BC4) 1X1 802.11n, Wireless Lan and CSR Bluecore4 Bluetooth2.1+EDR (Microsoft in-box driver, profiles;Motorola profiles) / software upgradable to BT3.0+HS(Motorola) Combo Mini Card
WiFi	570802010062	QCOM	Ralink 802.11b/g/N, 2T2R,(DSS-3000) Mini PCIe
Battery Kits	221401280000	CarTFT.com	Neosonic-Polymer 800mAH 3S1P Battery kit for FleetPC-4
OS	972009720000	Microsoft	Windows Embedded Standard 2009 (Windows XP Embedded)
OS	970022730000	Microsoft	Windows® 7 Professional for Embedded Systems x32/x64 (1-2 CPU) (ESD)